

# Model PPM1 & PPM2 Trace Moisture Analyzer OPERATORS MANUAL



PPM1



PPM2



399 River Road • Hudson, MA USA 01749  
Tel: 978 310-7760 • 800 276-3729 • Fax: 978 310-7767  
E-mail [h2o@edgetechinstruments.com](mailto:h2o@edgetechinstruments.com) • [www.edgetechinstruments.com](http://www.edgetechinstruments.com)

Rev. A      June 2010

# PPM1 / PPM2

## QUICK STARTUP GUIDE

### STARTUP

#### PPM1:

1. Remove the cover, and mount the PPM1 in an easily visible position.
2. See Wiring Diagram in Installation, Section 4.
3. Wire Sensor connections.
4. Wire Power connections. Do not turn on Power at this time.
5. Wire two Analog (4 to 20 mA) Outputs if required.
6. Wire two Alarm Relays if required.
7. Wire and plug in the RS-232 connector if required.
8. Replace the outer cover. Do not over-tighten the screws.
9. Connect Sensor to dry gas source. Allow system time to dry out.
10. Turn on the Power Supply. Specifications are:  
18 to 30 Vdc, unregulated, 100 mA max.
11. After the self-test procedure, start viewing or recording valid data.

#### PPM2:

1. Fully charge the rechargeable battery before operating.
2. Connect Sensor to dry gas source. Allow system time to dry out.
3. After the self-test procedure, start viewing valid data.

| <b>TABLE OF CONTENTS</b>                  | <b>Page</b> |
|-------------------------------------------|-------------|
| 1.0 Quick Startup Guide                   | 2           |
| 2.0 Commitment to Quality                 | 5           |
| 3.0 Introduction                          | 6           |
| 3.1 General Description                   | 6           |
| 3.2 Technical Description                 | 6           |
| 3.2.1 The PPM1/PPM2 System                | 6           |
| 3.2.2 The Phosphorous Pentoxide Sensor    | 6           |
| 3.2.3 Standard Factory Ranges             | 8           |
| 3.2.4 Gases to Avoid                      | 9           |
| 4.0 Installation                          | 9           |
| 4.1 Placement of Instrument               | 9           |
| 4.2 Mounting                              | 9           |
| 4.2.1 Wall Mounting the Display           | 9           |
| 4.2.2 Sensor Mounting and Sampling        | 9           |
| 4.3 Electrical Wiring                     | 10          |
| 4.3.1 Sensor Connections                  | 10          |
| 4.3.2 Power Connections                   | 10          |
| 4.3.3 Analog Outputs                      | 10          |
| 4.3.4 Alarm Relays                        | 10          |
| 4.3.5 RS-232 Serial Port                  | 10          |
| 5.0 Operation                             |             |
| 5.1 Startup                               | 12          |
| 5.1.1 Dry Down Phase 1                    | 12          |
| 5.1.2 Dry Down Phase 2                    | 12          |
| 5.2 Measuring Dry Gases                   | 13          |
| 5.2.1 Measurement Time                    | 13          |
| 5.2.2 Materials                           | 13          |
| 5.3 Operating the Instruments             | 13          |
| 5.3.1 The PPM1                            | 13          |
| 5.3.2 The PPM2                            | 13          |
| 5.4 Using the RS-232 Port for Programming | 14          |
| 5.4.1 Serial Port Setup                   | 14          |
| 5.4.2 Changing the Digital Display        | 14          |
| 5.4.3 Changing the Analog Outputs         | 15          |
| 5.4.4 Programming the Alarm Relays        | 17          |
| 5.4.5 Calibrating the Analog Outputs      | 20          |
| 5.4.6 Modifying the RS-232 Parameters     | 21          |

|       |                            |    |
|-------|----------------------------|----|
| 6.0   | Maintenance                | 23 |
| 6.1   | General                    | 23 |
| 6.1.1 | Filters                    | 23 |
| 6.1.2 | Battery Maintenance        | 23 |
| 6.2   | Gases                      | 23 |
| 7.0   | Specifications             | 24 |
| 8.0   | Appendix                   | 26 |
| 8.1   | PPM1 Mounting Dimensions   | 26 |
| 8.2   | Sensor Dimensions          | 27 |
| 8.3   | Warranty                   | 28 |
| 8.4   | Notes                      | 29 |
| 8.5   | Basic Humidity Definitions | 30 |

## **LIST OF ILLUSTRATIONS**

|     |                              |    |
|-----|------------------------------|----|
| 3-1 | Phosphorous Pentoxide Sensor | 7  |
| 3-2 | PPM1 Wall Mounted            | 7  |
| 3-3 | PPM2 Portable                | 8  |
| 4-1 | Wiring Connections           | 11 |

## 2.0 EDGETECH'S COMMITMENT TO QUALITY

To Our Customers:

Thank you for purchasing one of our products. At EdgeTech, it is our policy to provide cost-effective products and support services that meet or exceed your requirements, to deliver them on time, and to continuously look for ways to improve both. We all take great pride in the products we manufacture.

We want you to be entirely satisfied with your instrument. The information contained in this manual will get you started. It tells you what you need to get your equipment up and running, and introduces its many features.

We always enjoy hearing from the people who use our products. Your experience with our products is an invaluable source of information that we can use to continuously improve what we manufacture. We encourage you to contact or visit us to discuss any issues whatsoever that relate to our products or your application.

*The Employees of EdgeTech*

## 3.0 INTRODUCTION

### 3.1 GENERAL DESCRIPTION

The PPM1 is a trace moisture analyzer designed specifically for monitoring low levels of moisture, and reading them out in units of dew point and parts-per-million. This trace moisture analyzer utilizes an electro-chemical ( $P_2O_5$ ) sensor in combination with a proprietary semi-permeable diffusion membrane. The principal of operation applies the Faraday's Law of Electrolysis. It is a **fundamental measurement** of the moisture present. The PPM1 is ideally used in relatively clean, dry, inert gas applications. It is provided in a wall-mount configuration. See Figure 3-2.

The PPM2 is a portable, battery operated version of the PPM1. It is provided in a carrying case, with two gel-cell rechargeable batteries built in. See Figure 3-3.

### 3.2 TECHNICAL DESCRIPTION

#### 3.2.1 THE PPM1/PPM2 SYSTEM

The gas passing through the phosphorous pentoxide cell results in a small electrical current proportional to the quantity of water molecules (moisture) in the sample. The small electrical current from the cell is conditioned so that it directly corresponds to the concentration of moisture in the measured gas. This linear output signal is available to actuate the programmable Alarm Relays, and also provides information to the Digital Display and Analog Outputs. A microprocessor controls all data processing and input and output functions of the Instrument, ensuring a high accuracy measurement of moisture. Two separate humidity parameters may be monitored and displayed.

#### 3.2.2 THE PHOSPHOROUS PENTOXIDE ( $P_2O_5$ ) MOISTURE SENSOR

The Sensor utilizes an electrochemical (phosphorous pentoxide -  $P_2O_5$  - coated) sensor in combination with a proprietary semipermeable diffusion membrane. This membrane allows the water vapor molecules to pass from the dry gas stream into the sensor cavity at a rate that is a function of the partial pressure of the water across the membrane. It also allows the hydrogen and oxygen molecules, the byproducts of the electrolysis, to diffuse back into the gas stream.

The membrane "meters" the gas flowing into the sensor cavity, **ELIMINATING THE NEED FOR PRESSURE REGULATION AND CONSTANT FLOW**, which are required in most other electrolytic hygrometers.

The phosphorous pentoxide moisture sensor, also called an electrolytic cell, has the ability to measure trace quantities of water vapor in a dry gas. Operation is based on the fact that if a small dc voltage is applied, water vapor molecules can be electrolyzed into their elements of hydrogen and oxygen. To electrolyze each water molecule, it is known that two electrons are required. Therefore, the

quantity of current used by the cell is proportional to the number of water molecules being electrolyzed. If the dc excitation current is measured, water vapor content of the gas can be displayed. This measurement process provides a fundamental measurement of water vapor. While in a typical electrolytic cell the rate of gas flow must be carefully controlled by the user for accurate measurements, this cell is independent of gas flow rate. Although a fundamental measurement technique normally does not require calibration, each cell is calibrated at the Factory before shipment to the user to compensate for variations in the diffusion membranes. Figure 3-1 shows the moisture sensor.



Figure 3-1 The Phosphorous Pentoxide ( $P_2O_5$ ) Moisture Sensor

Figure 3-2 The PPM1 with Wall Mount housing and Moisture Sensor



Figure 3-3 The PPM2 Portable Trace Moisture Analyzer



Figure 3-2 shows the wall mounted PPM1, and Figure 3-3 shows the portable battery-operated PPM2.

### 3.2.3 STANDARD FACTORY RANGES

As received from the Factory, the instrument is programmed for the following standard conditions. These may be field modified by the user by using the RS-232 serial port. See the Operation section for complete programming information.

Digital Display Units: Set for ppmv and Dew Point

Analog Output Ranges: Set for 0 to 1250 ppmv, and -100°C to 0°C Dew Point

Alarm Relays Switching: Actuated at 100 ppmv, and -50°C Dew Point

RS-232 Port Update Rate: 5 seconds

### **3.2.4 GASES TO AVOID**

Caution: This instrument should not be used with gases that are corrosive or that readily combine with phosphorous pentoxide to form water. **GASES AND MATERIALS THAT SHOULD BE AVOIDED INCLUDE CERTAIN ACIDS, ALCOHOLS, CHLORINE, FLUORINE, HYDROGEN CHLORIDE, HYDROGEN FLUORIDE, AMINES, AMMONIA, ALKYNES, ALKADIENES, AND ALKENES.**

## **4.0 INSTALLATION**

### **4.1 PLACEMENT OF INSTRUMENT**

If possible, locate the PPM1 in a clean area. Choose a location where the display may be conveniently observed. Depending on the location selected, it may be convenient to wire the instrument prior to mounting.

### **4.2 MOUNTING**

#### **4.2.1 WALL MOUNTING THE DISPLAY**

The plastic wall mount housing is mounted to a flat surface as follows:

1. Remove the front cover. Using a flat screwdriver, carefully unscrew the four slotted plastic screws.
2. Mounting screws (not provided) are inserted in the same holes as the cover screws. They must have a head diameter that is small enough to fit inside the clearance holes, but large enough to press against the collar located at the bottom of the holes. No. 8 pan head or round head screws are recommended. See the wall mounting hole pattern in the Appendix of this manual.
3. Reinstall the front cover. Do not over-tighten the cover mounting screws.

#### **4.2.2 SENSOR MOUNTING AND SAMPLING SYSTEM**

The P<sub>2</sub>O<sub>5</sub> Moisture Sensor is designed to measure very small quantities of Water Vapor in the presence of other gases. It is manufactured of carefully selected non-hygroscopic materials such as stainless steel. The use of more porous materials such as plastic in your measuring system is strongly discouraged. In order to obtain correct readings and acceptable response times, the sensor sampling system must be carefully planned. Here are some recommendations:

- Tubing should be clean stainless steel, not plastic.
- If gas is brought from a long distance, use larger diameter tubing for faster response time. Reduce diameter at the sensor fitting.

- Leak check the system after installation.
- Purge the sampling system with dry gas after installation.
- Do not expose the sensor to excess pressure.
- Allow sufficient time for the system to dry out before attempting to take measurements.

The sensor gas connections are ¼ inch (6.35 mm) compression fittings. See the sensor mounting hole information in the Appendix of this manual.

If the gas to be measured is not completely clean, you may wish to install an upstream filter in the system. A sintered stainless steel filter element is recommended.

## **4.3 ELECTRICAL WIRING**

See Figure 4-1, the electrical wiring diagram. All connections are clearly marked on the circuit board.

### **4.3.1 SENSOR CONNECTIONS**

The connector end of the Sensor cable is plugged into the Sensor. The other (wired) end should be routed through the left hand feed-thru fitting at the bottom of the electronics housing. Two wires are connected to the terminals marked “SENSOR,” and the shield wire is connected to the terminal marked “CH GND”.

### **4.3.2 POWER CONNECTIONS**

Power is supplied by a user-furnished unregulated DC power supply. Voltage range may be between 18 and 30 VDC, at 100 mA maximum. Connect the positive side to +VIN, and the negative side to RTN.

### **4.3.3 ANALOG OUTPUTS**

The 4 to 20 mA Analog Outputs, if used, may be routed through the left-hand feed-thru fitting. The positive side of Output 1 is connected to the terminal marked OUT1, and the return to the adjacent terminal marked RTN. Similarly, Output 2 is connected to OUT2 and RTN.

### **4.3.4 ALARM RELAYS**

The Alarm Relays, if used, may be routed through the right-hand feed-thru fitting. The contacts are Normally Open. Two alarm wires may be connected to the terminals marked K1, and two may be connected to the terminals marked K2.

### **4.3.5 RS-232 SERIAL PORT**

The built-in serial port is bi-directional, and includes a Type DB-9 RS-232 connector mounted on the circuit board. Any industry standard RS-232 cable may be used. It is recommended that the installer wire the connector to one end of the cable *after* routing it through one of the feed-thru fittings mounted to the bottom of the electronics housing.

Figure 4-1 PPS1/PPS2 Wiring Connections

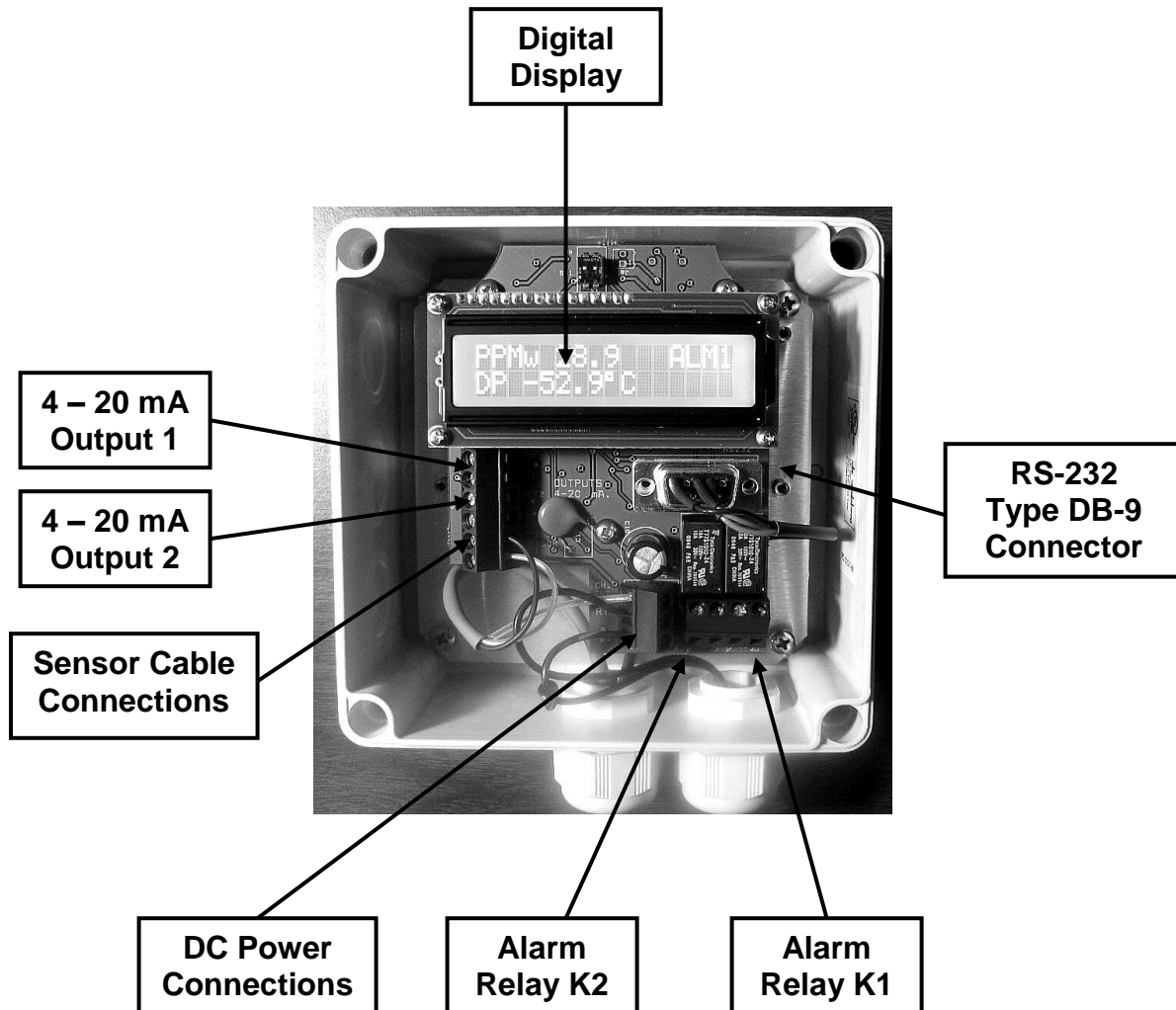

## 5.0 OPERATION

### 5.1 STARTUP

IT IS RECOMMENDED THAT A NEWLY INSTALLED INSTRUMENT BE DRIED DOWN WITH DRY INERT GAS SUCH AS BOTTLED NITROGEN BEFORE FINAL CONNECTION IS MADE BETWEEN THE SAMPLING SYSTEM AND THE PROCESS GAS STREAM.

#### 5.1.1 DRY DOWN PHASE 1

THE DRY GAS SHOULD FLOW THROUGH THE SAMPLING SYSTEM ONLY (BYPASSING THE SENSOR) FOR THE FIRST FEW HOURS.

*This procedure is recommended because during construction of the sampling system, the components are exposed to the moisture in the ambient air, which under normal conditions, can easily exceed 30,000 ppmv. These components will be in equilibrium with the ambient air (having adsorbed moisture on their surfaces). This water vapor will be desorbed from the walls of the tubing and other surfaces of the sampling system components once the gas sample starts to flow.*

Unless steps are taken to remove any moisture in advance by following the PHASE 1 dry down procedure, much of the moisture desorbed from the surfaces of the sampling system will enter the electrochemical cell, most probably exceeding the moisture concentration that the cell is designed to handle.

#### 5.1.2 DRY DOWN PHASE 2

THE FLOW OF DRY GAS SHOULD THEN BE ROUTED THROUGH BOTH THE CELL AND THE SAMPLING SYSTEM ASSEMBLY FOR AT LEAST ONE OR TWO HOURS.

*This procedure is recommended to dry down the measurement cell, and to equilibrate the entire sampling system.*

**NOTE: ONCE THE ANALYZER HAS BEEN POWERED, THE POWER SHOULD NOT BE SHUT OFF. FAILURE TO ADHERE TO THIS PROCEDURE COULD SHORTEN THE USEFUL LIFE OF THE MEASUREMENT CELL.**

*The rationale behind this recommendation is that if power is always applied to the measurement cell, any moisture that accidentally gets into the sampling chamber will be eliminated by electrolyzing the water vapor molecules. This keeps the moisture level on the phosphorous pentoxide low, lengthening its life.*

**NOTE: IT IS GOOD PRACTICE TO INSTALL A SHUTOFF VALVE ON EACH SIDE OF THE MEASUREMENT CELL, TO KEEP IT DRY WHEN OPENING THE SAMPLING SYSTEM.**

## **5.2 MEASURING DRY GASES**

### **5.2.1 MEASUREMENT TIME**

Measuring extremely dry gases is an art. Time and patience are involved. If you are in a hurry, you may not obtain accurate results. As discussed above, all materials are hygroscopic. That is, they have pores that retain water molecules. When the level of moisture in a gas is decreased, for example, it may take a very long time for all of the materials in the entire sampling system to outgas, or give off all the excess water molecules that are trapped in the pores of every inside surface of the system. Depending upon your unique conditions, it could take a number of hours for complete stabilization of the moisture level in your gas. Be sure you wait long enough before taking readings.

### **5.2.2 MATERIALS**

As discussed in the Installation chapter of this manual, selection of materials is extremely critical for proper dry gas sampling. For dry gas measurements, do not use PVC or other porous tubing. Some plastic tubing such as Impolene™ may be used for gases in the higher ppm ranges. For measuring gases in the lower ppm ranges, only stainless should be used.

If readings do not seem to stabilize after waiting a reasonable amount of time, check to see if you have a leak from outside the system where the vapor pressure is higher, or have excessively hygroscopic tubing, or possibly your stainless tubing is contaminated and requires cleaning.

## **5.3 OPERATING THE INSTRUMENTS**

### **5.3.1 THE PPM1**

There are no controls to operate on the PPM1. The operator simply monitors the digital display, or allows the analog and digital outputs to communicate with the data acquisition system. When you first turn on the system, a short self-check period occurs on the display, and then it quickly starts to show the two moisture parameters that it is programmed to display. These are changeable in the field, as shown in the following section on the Serial Port. The digital displays, as well as the electrical outputs, are constantly updated.

### **5.3.2 THE PPM2**

The PPM2 is a portable version of the PPM1. It is necessary to charge the built-in batteries before using it, and then to recharge them periodically. The charger is supplied with the system.

## 5.4 USING THE RS-232 SERIAL PORT TO PROGRAM YOUR SETTINGS

### 5.4.1 SERIAL PORT SETUP

Plug a standard RS-232 cable into the DB-9 connector on the circuit board in the PPM1 or PPM2. Plug the other end into your terminal or computer. If your computer does not have a serial port, you will have to obtain a USB to Serial adaptor, install the driver for it, and use the USB port.

Using a communications program such as Hyperterminal or equivalent, program the settings as follows:

- Baud Rate: 19.2K
- Data Bits: 8
- Parity: None
- Stop Bit: 1
- Flow Control: None

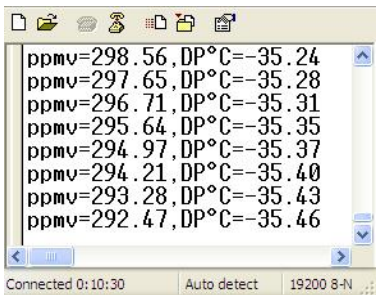

```
ppmv=298.56,DP°C=-35.24
ppmv=297.65,DP°C=-35.28
ppmv=296.71,DP°C=-35.31
ppmv=295.64,DP°C=-35.35
ppmv=294.97,DP°C=-35.37
ppmv=294.21,DP°C=-35.40
ppmv=293.28,DP°C=-35.43
ppmv=292.47,DP°C=-35.46
```

Connected 0:10:30 Auto detect 19200 8-N

You should now see flowing data on your monitor, displaying the same information that is shown on the PPM1 or PPM2 Digital Display, with a periodic update rate. If you do not, check your serial port settings and cable connections.

### NOTES:

1. WHEN PROGRAMMING ALPHABETIC CHARACTERS, USE UPPER CASE ONLY.
2. IF YOU HAVE MORE THAN ONE WINDOW OPEN ON YOUR DESKTOP, CLICK ON THE HYPERTERMINAL WINDOW TO SELECT IT BEFORE PROGRAMMING.

### 5.4.2 CHANGING THE DIGITAL DISPLAY

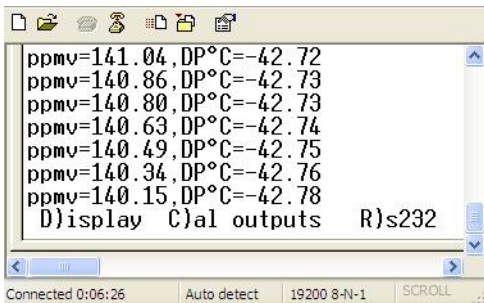

```
ppmv=141.04,DP°C=-42.72
ppmv=140.86,DP°C=-42.73
ppmv=140.80,DP°C=-42.73
ppmv=140.63,DP°C=-42.74
ppmv=140.49,DP°C=-42.75
ppmv=140.34,DP°C=-42.76
ppmv=140.15,DP°C=-42.78
D)isplay C)al outputs R)s232
```

Connected 0:06:26 Auto detect 19200 8-N-1 SCROLL

You can select any two of several measured or calculated parameters to appear on the front panel Digital Display. Proceed as follows:

Press the “Escape” key on your keyboard. You will see three items that you can program; D)isplay, C)al outputs, and R)s232, as shown here. Since we are planning to

select Display parameters, press “D” for Display. (We will C)alibrate the Outputs and modify the R)s232 later.)

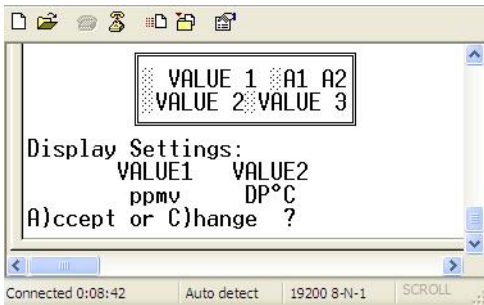

Note that initially, the displays are showing units of ppmv (parts-per-million by volume) and Dew Point in degrees C. First, we will change ppmv to ppmw (parts-per-million by weight).

You are given a choice whether to keep the present units or to C)hange them. In this case, we will select to C)hange them. Press “C” on your keyboard. Select “Value 1” to change ppmv.

**NOTE:**  
**PRESSING THE SPACE BAR SCROLLS THROUGH ALL THE AVAILABLE SELECTIONS. PRESS “ENTER” TO SELECT THE ONE YOU WANT TO KEEP.**

Press the Space Bar several times to see what units are available. When you see ppmw, press “Enter”. You will then see the window below. Press “Enter” again.

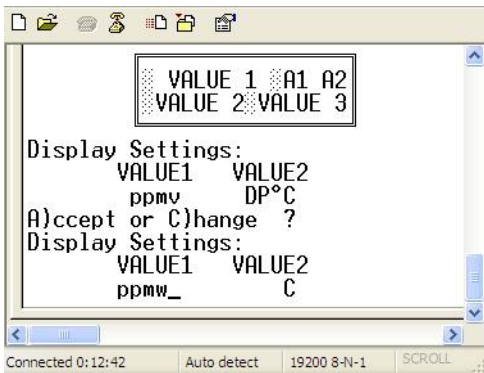
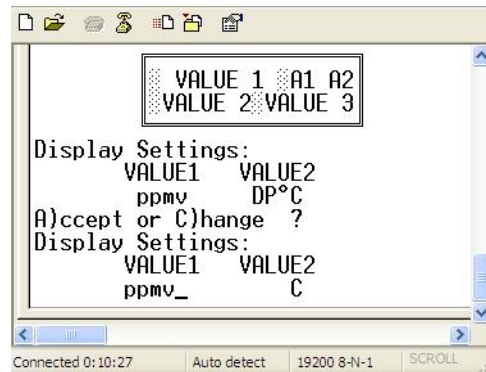

Then, you will be given a choice whether to A)cccept or C)hange this modification. Press “A” for A)cccept.

### 5.4.3 CHANGING THE ANALOG OUTPUT RANGES

Continuing on, you will now be given the opportunity to modify the Analog Outputs. You do not have to go back to the main menu to do this, since it will automatically be the next step.

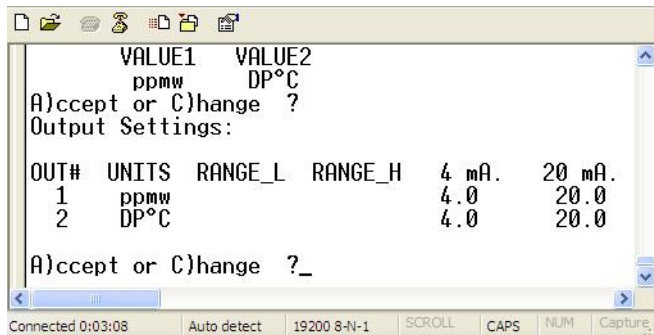

```

ppmw  DP°C
A)cept or C)hange ?
Output Settings:
OUT# UNITS RANGE_L RANGE_H 4 mA. 20 mA.
 1 ppmw 4.0 20.0
 2 DP°C 4.0 20.0
A)cept or C)hange ?
Set Output 1) 2) or eX)it ?_

```

Connected 0:06:54 Auto detect 19200 8-N-1 SCROLL CAPS NUM Capture...

In this example, let's change the 4 to 20 mA Analog Output so that it corresponds to Dew Point in °F instead of Dew Point in °C. Press "C" for C)hange. You will then see this window. Press "2" to Set Output 2, which corresponds to Dew Point in °C.

Again, use the Space Bar to scroll through the available options, and then use Enter to select the one you want. If you wish, you can also change the measurement range that 4 to 20 mA corresponds to at this time.

```

OUT# UNITS RANGE_L RANGE_H 4 mA. 20 mA.
 1 ppmw 4.0 20.0
 2 DP°C 4.0 20.0
A)cept or C)hange ?
Set Output 1) 2) or eX)it ?
UNITS: <SP> to SCROLL, <ENTER> to SELECT
OUT# UNITS RANGE_L RANGE_H 4 mA. 20 mA.
 2 DP°C 10.0 -150.0_

```

Connected 0:08:31 Auto detect 19200 8-N-1 SCROLL CAPS NUM Capture...

```

 2 DP°C 4.0 20.0
A)cept or C)hange ?
Set Output 1) 2) or eX)it ?
UNITS: <SP> to SCROLL, <ENTER> to SELECT
OUT# UNITS RANGE_L RANGE_H 4 mA. 20 mA.
 2 DP°F 50.0 0.0 4.0 20.0
Save Changes Y)es N)o ?
Set Output 1) 2) or eX)it ?_

```

Connected 0:11:11 Auto detect 19200 8-N-1 SCROLL CAPS NUM Capture...

We have selected DP°F, as shown here. Next, press "X" for eX)it.

Finally, press "A" to A)cept the change. You have completed the process of modifying the Analog Output.

```

 2 DP°F 50.0 0.0 4.0 20.0
Save Changes Y)es N)o ?
Set Output 1) 2) or eX)it ?
Output Settings:
OUT# UNITS RANGE_L RANGE_H 4 mA. 20 mA.
 1 ppmw 4.0 20.0
 2 DP°F 4.0 20.0
A)cept or C)hange ?_

```

Connected 0:14:43 Auto detect 19200 8-N-1 SCROLL CAPS NUM Capture...

#### 5.4.4 PROGRAMMING THE ALARM RELAYS

Next, you will be given the opportunity to modify the alarm settings if you wish. Again you do not have to go back to the main menu, since the next step will automatically put you in this mode.

The PPM1 and PPM2 have two alarms. They are Form A, (single-pole, single-throw) normally open. You can make them correspond to any of the available measured or calculated measurement parameters. You can independently program the “ON” point and the “OFF” point for each relay. To enter the menu, press “C” for C)hange.

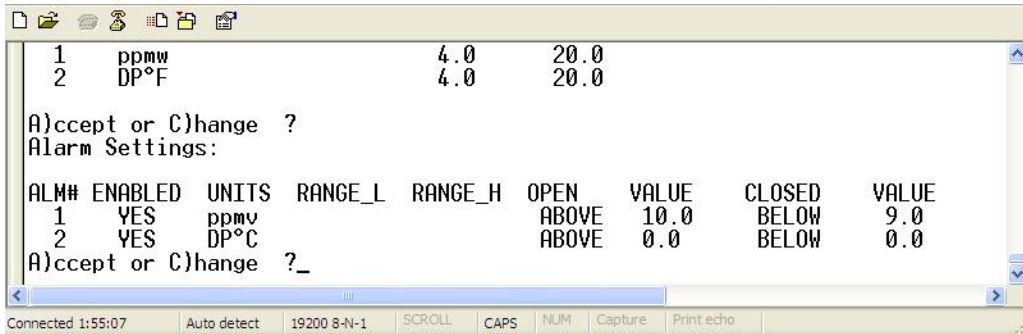

```
1 ppmw 4.0 20.0
2 DP°F 4.0 20.0

A)cccept or C)hange ?
Alarm Settings:

ALM# ENABLED UNITS RANGE_L RANGE_H OPEN VALUE CLOSED VALUE
1 YES ppmv ABOVE 10.0 BELOW 9.0
2 YES DP°C ABOVE 0.0 BELOW 0.0

A)cccept or C)hange ?_
```

You will then see the window shown below. In this example, we would like to change Alarm 2. Note that it is now set for Dew Point in °C, and the relay switches at 0.0 degrees. We are going to change it so that the alarm is now on Dew Point in °F. We want the relay to open when the measurement is above 25°F, and we want it to close when the measurement is below 24°F. Therefore, press “C” for C)hange.

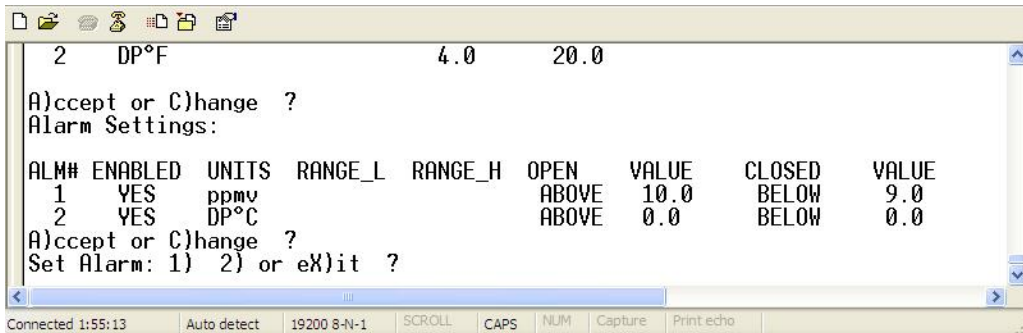

```
2 DP°F 4.0 20.0

A)cccept or C)hange ?
Alarm Settings:

ALM# ENABLED UNITS RANGE_L RANGE_H OPEN VALUE CLOSED VALUE
1 YES ppmv ABOVE 10.0 BELOW 9.0
2 YES DP°C ABOVE 0.0 BELOW 0.0

A)cccept or C)hange ?
Set Alarm: 1) 2) or ex)it ?
```

You will now see the window shown here. Press “2” to select Alarm 2.

As before, you can use the Space Bar to select the desired unit and the Enter key to lock it in. You can also choose to Enable or Disable any alarm. See the following window.

```

ALM# ENABLED UNITS RANGE_L RANGE_H OPEN VALUE CLOSED VALUE
1 YES ppmv ABOVE 10.0 BELOW 9.0
2 YES DP°C ABOVE 0.0 BELOW 0.0
A)cept or C)hange ?
Set Alarm: 1) 2) or eX)it ?
ENABLE & UNITS: <SP> to SCROLL, <ENTER> to SELECT

ALM# ENABLED UNITS RANGE_L RANGE_H OPEN VALUE CLOSED VALUE
2 YES_

```

Connected 1:55:21 Auto detect 19200 8-N-1 SCROLL CAPS NUM Capture Print echo

As you cycle through, you will be given the opportunity to replace DP°C with DP°F, as shown here. At this time you can also change the measurement range if you wish to. We will leave the default °F range of 50.0 to 0.0.

```

ALM# ENABLED UNITS RANGE_L RANGE_H OPEN VALUE CLOSED VALUE
1 YES ppmv ABOVE 10.0 BELOW 9.0
2 YES DP°C ABOVE 0.0 BELOW 0.0
A)cept or C)hange ?
Set Alarm: 1) 2) or eX)it ?
ENABLE & UNITS: <SP> to SCROLL, <ENTER> to SELECT

ALM# ENABLED UNITS RANGE_L RANGE_H OPEN VALUE CLOSED VALUE
2 YES DP°C 10.0 -150.0_

```

Connected 1:55:35 Auto detect 19200 8-N-1 SCROLL CAPS NUM Capture Print echo

```

ALM# ENABLED UNITS RANGE_L RANGE_H OPEN VALUE CLOSED VALUE
1 YES ppmv ABOVE 10.0 BELOW 9.0
2 YES DP°C ABOVE 0.0 BELOW 0.0
A)cept or C)hange ?
Set Alarm: 1) 2) or eX)it ?
ENABLE & UNITS: <SP> to SCROLL, <ENTER> to SELECT

ALM# ENABLED UNITS RANGE_L RANGE_H OPEN VALUE CLOSED VALUE
2 YES DP°F 50.0 0.0

```

Connected 1:55:39 Auto detect 19200 8-N-1 SCROLL CAPS NUM Capture Print echo

Next, we will program the alarm relay to open when the measurement is above 25 degrees, and close when the measurement is below 24 degrees.

**NOTE: IT IS NOT GOOD PRACTICE TO SET THE “OPEN” POINT AND THE “CLOSE” POINT TO THE SAME NUMBER. THIS MAY CAUSE EXCESSIVE RELAY CHATTERING WHEN THE MEASUREMENT IS AT THAT QUANTITY.**

```

ALM# ENABLED UNITS RANGE_L RANGE_H OPEN VALUE CLOSED VALUE
1 YES ppmv ABOVE 10.0 BELOW 9.0
2 YES DP°C ABOVE 0.0 BELOW 0.0
A)cept or C)hange ?
Set Alarm: 1) 2) or eX)it ?
ENABLE & UNITS: <SP> to SCROLL, <ENTER> to SELECT

ALM# ENABLED UNITS RANGE_L RANGE_H OPEN VALUE CLOSED VALUE
2 YES DP°F 50.0 0.0 ABOVE 25_

```

Connected 1:55:52 Auto detect 19200 8-N-1 SCROLL CAPS NUM Capture Print echo

```

1 YES ppmv ABOVE 10.0 BELOW 9.0
2 YES DP°C ABOVE 0.0 BELOW 0.0
A)cept or C)hange ?
Set Alarm: 1) 2) or eX)it ?
ENABLE & UNITS: <SP> to SCROLL, <ENTER> to SELECT

ALM# ENABLED UNITS RANGE_L RANGE_H OPEN VALUE CLOSED VALUE
2 YES DP°F 50.0 0.0 ABOVE 25.0 BELOW 24.0
Save Changes Y)es N)o ?

```

Connected 1:56:01 Auto detect 19200 8-N-1 SCROLL CAPS NUM Capture Print echo

Next, we are asked if we want to Save the Changes, and we press “Y” for Y)es.

```

2 YES DP°C ABOVE 0.0 BELOW 0.0
A)cept or C)hange ?
Set Alarm: 1) 2) or eX)it ?
ENABLE & UNITS: <SP> to SCROLL, <ENTER> to SELECT

ALM# ENABLED UNITS RANGE_L RANGE_H OPEN VALUE CLOSED VALUE
2 YES DP°F 50.0 0.0 ABOVE 25.0 BELOW 24.0
Save Changes Y)es N)o ?
Set Alarm: 1) 2) or eX)it ?

```

Connected 1:56:07 Auto detect 19200 8-N-1 SCROLL CAPS NUM Capture Print echo

Now, we can select “X” for eX)it, and then “A” to A)cept the changes.

```

ALM# ENABLED UNITS RANGE_L RANGE_H OPEN VALUE CLOSED VALUE
2 YES DP°F 50.0 0.0 ABOVE 25.0 BELOW 24.0
Save Changes Y)es N)o ?
Set Alarm: 1) 2) or eX)it ?
Alarm Settings:

ALM# ENABLED UNITS RANGE_L RANGE_H OPEN VALUE CLOSED VALUE
1 YES ppmv ABOVE 10.0 BELOW 9.0
2 YES DP°F ABOVE 25.0 BELOW 24.0
A)cept or C)hange ?

```

Connected 1:56:13 Auto detect 19200 8-N-1 SCROLL CAPS NUM Capture Print echo

We have now made all the desired changes, and the display defaults to the standard Hyperterminal window with periodic updates. See the illustration below.

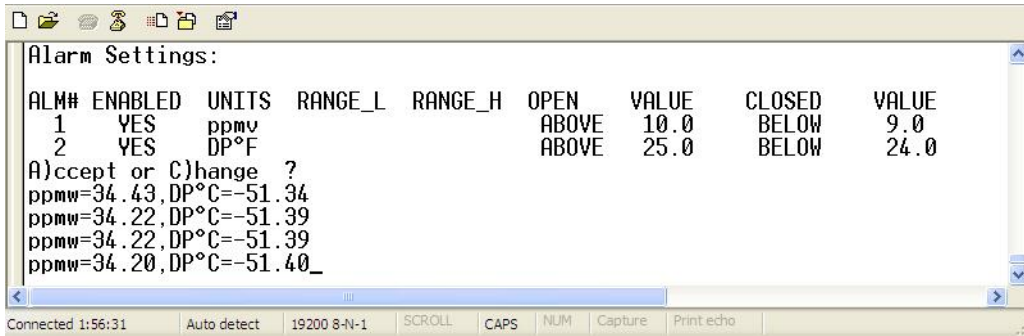

### 5.4.5 CALIBRATING THE ANALOG OUTPUTS

If you have a precise milliammeter, the PPM1 and PPM2 allow you to check the calibration of the two 4 to 20 mA analog outputs. In order to utilize this capability, connect the meter in series with one of the analog outputs and the load. Observe the correct meter polarity. Press the “Escape” key on your

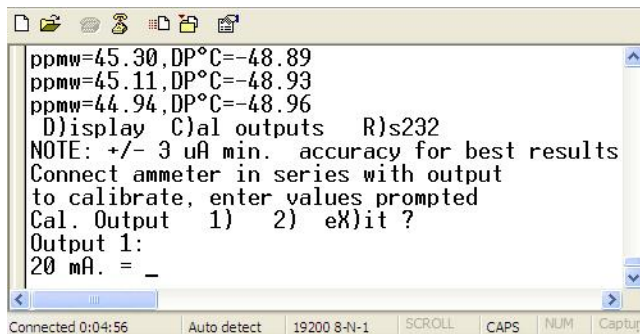
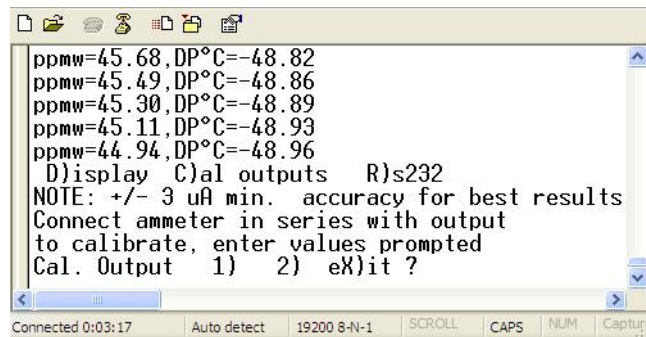

keyboard, which will interrupt the data stream and give you the Calibration option. Then, press “C” for C)alibrate. For this example, select Output 1 to calibrate. Next, read your precision ammeter, which will give you the high end current. It should read around 20 mA. In this case, the actual reading is 19.9 mA as shown. Type this value in.

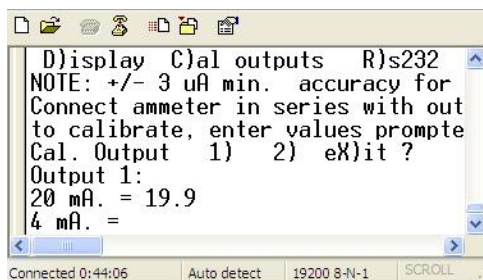

Next, read the low end output current. It should be about 4 mA.

```

Connect ammeter in series with out
to calibrate, enter values prompte
Cal. Output 1) 2) eX)it ?
Output 1:
20 mA. = 19.9
4 mA. = 4.0
Ammeter READS 11.975 - 12.025
Cal. Output 1) 2) eX)it ?_

```



Type it in as shown above. The system then will show you the predicted midpoint reading, which in this case should be within the range of between 11.975 and 12.025 mA. This takes the cumulative system errors in account.



```

Output 1:
20 mA. = 19.9
4 mA. = 4.0
Ammeter READS 11.975 - 12.025
Cal. Output 1) 2) eX)it ?
ppmw=41.52, DP°C=-49.68
ppmw=37.24, DP°C=-50.65
ppmw=37.26, DP°C=-50.64

```

As shown here the reading is exactly 12 mA, and the system is within specifications. Finally, press “X” for E)xit, and the Hyperterminal window will return to the default mode, showing continuous updates.

### 5.4.6 MODIFYING THE RS-232 PORT PARAMETERS

Two RS-232 Port parameters may be changed in the field. You can enable the Elapsed Time Stamp, and you can modify the Update Rate. To start, proceed as follows:

```

ppmw=22.43, DP°C=-55.01
ppmw=22.43, DP°C=-55.01
ppmw=22.42, DP°C=-55.01
ppmw=22.42, DP°C=-55.02
ppmw=22.41, DP°C=-55.02
D)isplay C)al outputs R)s232
T)ime R)ate eX)it
Enable Elapsed Time Stamp(Y N)?

```

From the normal updating mode as shown here, press “R” for Rs232. You can then press “T” to select the Elapsed Time Stamp, or press “R” to select the Update Rate. In this example we will leave the

```

T)ime R)ate eX)it
ppmw=22.65, DP°C=-54.93
ppmw=22.59, DP°C=-54.95
ppmw=22.59, DP°C=-54.95
ppmw=22.58, DP°C=-54.95
D)isplay C)al outputs R)s232
T)ime R)ate eX)it

```

Elapsed Time Stamp disabled, but we will change the Update Rate. See the Windows shown below.

First, press “R” to select the Update Rate. You have a choice of rates from 1 to 3600 seconds (1 second to 1 hour).

```
ppmw=22.42,DP°C=-55.02
ppmw=22.41,DP°C=-55.02
D)isplay C)al outputs R)s232
T)ime R)ate eX)it
Enable Elapsed Time Stamp(Y N)?
Time StampDisabled
T)ime R)ate eX)it
Serial Rate Secs(1-3600)?
```

Connected 0:35:34 Auto detect 19200 8-N-1 SCROLL

```
ppmw=22.42,DP°C=-55.01
ppmw=22.42,DP°C=-55.02
ppmw=22.41,DP°C=-55.02
D)isplay C)al outputs R)s232
T)ime R)ate eX)it
Enable Elapsed Time Stamp(Y N)?
Time StampDisabled
T)ime R)ate eX)it_
```

Connected 0:35:27 Auto detect 19200 8-N-1 SCROLL

For this example we will insert an Update Rate of 5 seconds, which is a convenient rate to watch data updating on the computer monitor. See the

window on the right. Once that is done, you only have to press “X” for eX)it, and you will be back in the default updating mode as shown below.

```
D)isplay C)al outputs R)s232
T)ime R)ate eX)it
Enable Elapsed Time Stamp(Y N)?
Time StampDisabled
T)ime R)ate eX)it
Serial Rate Secs(1-3600)? 5
Serial Rate 5
T)ime R)ate eX)it
```

Connected 0:35:46 Auto detect 19200 8-N-1 SCROLL

```
Time StampDisabled
T)ime R)ate eX)it
Serial Rate Secs(1-3600)? 5
Serial Rate 5
T)ime R)ate eX)it

ppmw=22.40,DP°C=-55.02
ppmw=22.34,DP°C=-55.04_
```

Connected 0:35:55 Auto detect 19200 8-N-1 SCROLL

You have now completed all the programming of the PPM1 or PPM2. You can go back at any time and easily modify any parameter in the field.

## **6.0 MAINTENANCE**

### **6.1 GENERAL**

Very little maintenance is required for long term operation of the PPM1 and PPM2 Trace Moisture Analyzers. They have been designed for continuous operation over very long periods of time. The electronics unit needs no maintenance. The trace moisture sensor may gradually get contaminated, and may have to be returned to the Factory for cleaning after very long periods of operation.

#### **6.1.1 FILTERS**

It is considered good practice to have an upstream particle filter in the line. It will keep the moisture sensor clean and will keep dust and other contaminants out of the cavity. The filter should be non-hygroscopic, and preferably should be made of sintered stainless steel. A maintenance schedule should be set up to clean or replace the element periodically. A clogged filter will retain moisture and slow down the system.

#### **6.1.2 BATTERY MAINTENANCE**

The PPM2 Portable Analyzer contains a pair of gel cell batteries. These must be periodically recharged. A plug-in charger is included with the system. After a few discharge cycles to determine available operating time, you should be able to initiate a preventative maintenance program for periodic recharging that will keep the unit ready for use. If desired, the battery charger may be plugged into the PPM2 continuously without harm.

### **6.2 GASES**

Certain gases must never be used with this system. See **GASES TO AVOID** in the Introduction section of this manual. The use of these gases may damage or contaminate the moisture sensor.

## 7.0 SPECIFICATIONS

|                                                    |                                                                                                                                                                                                                                                          |
|----------------------------------------------------|----------------------------------------------------------------------------------------------------------------------------------------------------------------------------------------------------------------------------------------------------------|
| <b>Technology Used:</b>                            | P <sub>2</sub> O <sub>5</sub> , Phosphorous Pentoxide Cell                                                                                                                                                                                               |
| <b>Measured Parameter:</b>                         | PPMv (Parts-per-Million by Volume)                                                                                                                                                                                                                       |
| <b>Calculated Parameters:</b>                      | Dew Point, PPMw (Parts-per-Million by Weight), Others                                                                                                                                                                                                    |
| <b>Accuracy:</b>                                   | ± 5% of PPMv reading, typical                                                                                                                                                                                                                            |
| <b>Measurement Range:</b>                          | PPMv: 1250 to 0.1 ppm<br>Dew Point: -20°C to -95°C                                                                                                                                                                                                       |
| <b>Pressure:</b>                                   | 0 to 200 psig                                                                                                                                                                                                                                            |
| <b>Response Time:</b>                              | 90% of step change in one minute, typical                                                                                                                                                                                                                |
| <b>Hysteresis:</b>                                 | None                                                                                                                                                                                                                                                     |
| <b>Temperature:</b>                                | Ambient: 0 to 50°C<br>Sample Gas: 0 to 50°C                                                                                                                                                                                                              |
| <b>Electrical Outputs:</b><br>(Field Programmable) | Analog Outputs (2): 4 to 20 mA<br>Load: 0 to 400Ω<br><br>Digital Interface: RS-232C, bi-directional<br>DB-9 Connector<br><br>Alarm Relays (2): Form A (Normally Open)<br>Contact Rating: 3A at 250VAC/30VDC<br><br>Digital Display: LCD, 2 line, backlit |
| <b>Sensor Gas Connections:</b>                     | ¼ inch (6.35 mm) compression fittings                                                                                                                                                                                                                    |
| <b>Model PPM1:</b>                                 |                                                                                                                                                                                                                                                          |
| <b>Power Requirements:</b>                         | 18 to 30 VDC unregulated, 100 mA maximum                                                                                                                                                                                                                 |
| <b>Standard Cable:</b>                             | 6 feet (1.8 meter)                                                                                                                                                                                                                                       |
| <b>Dimensions:</b>                                 | Enclosure (LWD): 5.1 in (13cm) X 5.1 in<br>(13cm) X 3 in (7.6cm)                                                                                                                                                                                         |

**Weight:** Entire System: 4 lbs (1.8kg)

**Available PPM1**

**Options/Accessories:** Right angle mounting bracket (-MB)  
Additional sensor cable length (-SCBL)  
Note: Specify length to 500 ft. max.

**Model PPM2:**

**Power Requirements:** Battery Powered, 2 gel cells (12 VDC) in series  
Battery Charger included  
(115/230Vac to 24Vdc)  
Nominal Operating Time: 8 to 10 hours

**Standard Cable:** 6 feet (1.8 meter)

**Dimensions:** Carry Case (LWD): 19 in (48cm) X 14 in  
(36cm) X 7 in 18cm)

**Weight:** Entire System: 15 lbs. (6.8kg)

**Available PPM2 Optional Configurations:**

| <b>MODEL</b>     | <b>APPLICATION</b>             | <b>DESCRIPTION</b>                                                           |
|------------------|--------------------------------|------------------------------------------------------------------------------|
| <b>PPM2 – FV</b> | Positive Pressure              | A portable battery powered trace moisture analyzer with built-in Flow Valve  |
| <b>PPM2 - VP</b> | Atmospheric Pressure or Vacuum | A portable battery powered trace moisture analyzer with built-in Vacuum Pump |

## 8.0 APPENDIX

### 8.1 PPM1 MOUNTING DIMENSIONS

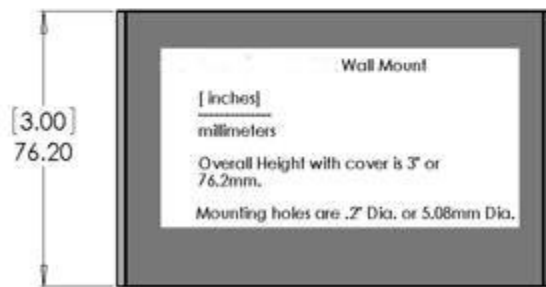
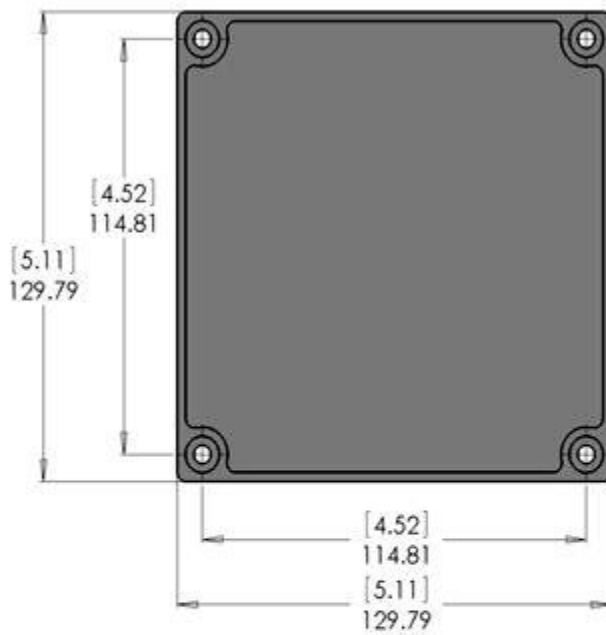

## 8.2 SENSOR DIMENSIONS

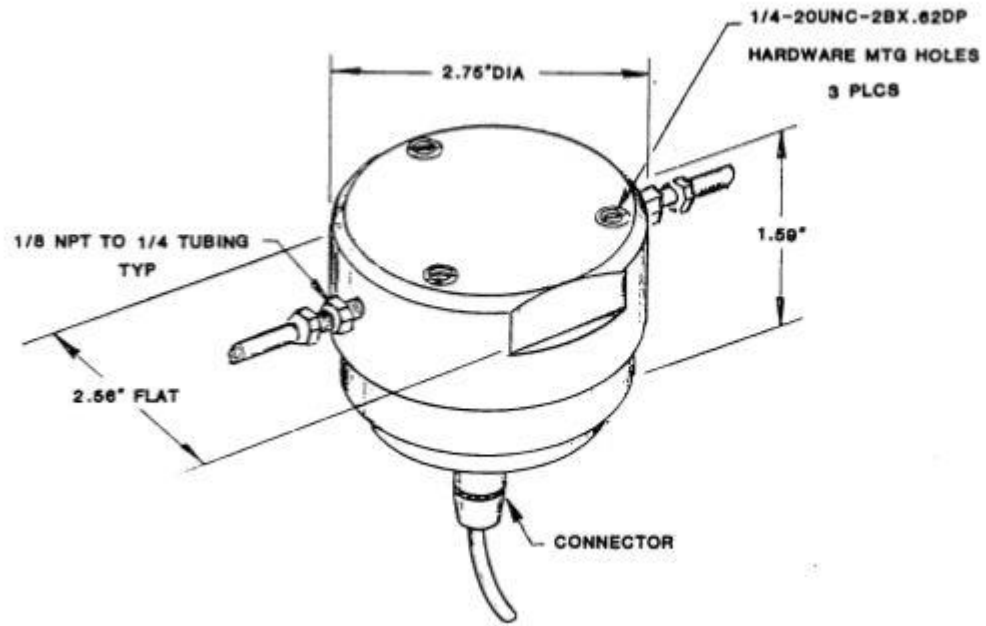

### **8.3 EDGETECH INSTRUMENT'S WARRANTY**

All equipment manufactured by Edgetech Instruments Inc. is warranted against defective components and workmanship, and will be repaired at their plant in Massachusetts, free of charge, for a period of twelve months. Malfunction due to improper use is not covered in this warranty and Edgetech Instruments disclaims any liability for consequential damage resulting from defects in the performance of the equipment. No product is warranted as being fit for a particular purpose and there is no warranty of merchantability. This warranty applies only if (i) the items are used solely under the operating conditions and in the manner recommended in the instruction manual, specifications, or other literature; (ii) the items have not been misused or abused in any manner or repairs attempted thereon; (iii) written notice of the failure within the warranty period is forwarded to Edgetech Instruments and the directions received for properly identifying items returned under warranty are followed; and (iv) the return notice authorizes Edgetech Instruments to examine and disassemble returned products to the extent Edgetech Instruments deems necessary to ascertain the cause for failure. The warranties expressed here are exclusive. There are no other warranties, either expressed or implied, beyond those set forth here, and Edgetech Instruments does not assume any other obligation or liability in connection with the sale or use of these products.

Equipment not manufactured by Edgetech Instruments is supported only to the extent of the original manufacturer's warranties.

## Notes