

# DewMaster X3LC

Chilled Mirror Hygrometer  
OPERATORS MANUAL



 **Edgetech Instruments**

399 River Road • Hudson, MA USA 01749

Tel. +1 978 310-7760 • +1 800 276-3729 • Fax +1 978 310-7767

E-mail [H2O@edgetechinstruments.com](mailto:H2O@edgetechinstruments.com) • [www.edgetechinstruments.com](http://www.edgetechinstruments.com)



## QUICK STARTUP GUIDE – Page 1

### STARTUP

1. Connect the DewMaster to the AC Power Line.
2. If the Remote Mounting Kit was ordered, connect Dew Point Sensor Cable to rear panel and to the Dew Point Sensor.
3. Connect Air Temperature Sensor to rear connector.
4. Install optional Pressure Sensor if required.
5. Wire Analog Outputs and Alarm Relay connections as needed.
6. Connect Serial Port if needed.
7. Install sampling system to Dew Point Sensor ports as needed.
8. Set rear panel Power Switch to ON position.
9. Wait for equilibration and SERVOLOCK indication on Display.

### REPROGRAMMING A SETTING

1. Press ENT on Keypad to enter selection menu.
2. Using the UP and DOWN and LEFT and RIGHT arrow keys, scroll to the desired location of the parameter to be changed.
3. Press ENT again to begin changing the setting. The selected parameter will flash. Use left and right Arrow keys as required to scroll to the location of the digit to be changed. Use the numerical keypad to input the change.
4. When programming is completed, press ENT to accept the new setting and ESC to exit the menu. The KEEP CHANGES? screen will appear. Press ENT to lock in the change, or ESC to discard the change and return to the previously programmed value.



**Edgetech Instruments**  
**DewMaster**

**QUICK STARTUP GUIDE – Page 2**

**ROUTINE MAINTENANCE (See Maintenance Section)**

**MIRROR CLEANING**

The Automatic Balance Cycle (ABC) greatly minimizes cleaning requirements of the internal Chilled Mirror Sensor. Contaminants in the air will gradually build up on the mirror, to the point where manual cleaning is eventually required. Periods of 90 days between cleanings are typical, depending on the air source. An indication of CLEAN MIRROR on the Display, after an ABC Cycle, will tell the user when cleaning is needed. Use cotton swabs and isopropyl alcohol for mirror cleaning. The manual shows the mirror location inside the Sensor.

**AIR FILTER ELEMENT REPLACEMENT**

If a Sampling System is used with the Chilled Mirror Sensor, mirror cleaning can be minimized by using an in-line air filter in the system. Depending upon the quantity of contaminants in the incoming air, the Air Filter element may have to be replaced after a substantial period of operation. Remove the air filter cover, replace the filter with a new one, and reassemble.

# TABLE OF CONTENTS

# Page

1.0 Quick Startup Card (Removable)	
2.0 List of Illustrations	7
3.0 Introduction	8
3.1 General Description	8
3.2 System Overview	8
3.3 Dew Point Sensor	9
3.4 Control Unit	9
3.5 Instrument Options	10
3.5.1 Measured Parameters	10
3.5.2 Analog Outputs	10
3.5.3 Alarm Relay	10
3.5.4 Pressure	10
3.6 Available Accessories	10
3.6.1 Remote Sensor Mounting Kit	10
3.6.2 Available Sample Line Filters	10
3.6.3 Sample Module Kit	10
4.0 Warranty Statement	11
5.0 Quality Statement	12
6.0 N.I.S.T. Traceability	13
7.0 Glossary	14
8.0 Installation	15
8.1 Unpacking	15
8.2 Control Unit Installation	15
8.2.1 Control Unit Placement	15
8.2.2 Wiring Connections	15
8.3 Sensor Setup for Accurate Dew Point Measurements	15
8.3.1 Sample Connections	15
8.3.2 Coolant Connections	15
8.3.3 Sampling Configurations	17
8.3.4 Preheating Sensor and Sample Lines	18
8.3.5 Selection of Components - Low Dew Points	19
8.3.6 Material Moisture Properties	19
8.3.7 Selection of Sample Pumps	20
8.3.8 Recommended Hardware	21
8.3.9 Pressure Measurements	21

8.4	Sources of Contamination	21
8.5	Sample Flow Rate	22
9.0	Basic Block Diagram Theory of Operation	24
9.1	Basic Block Diagram Description	25
10.0	Panel Description	26
10.1	Front Panel	26
10.2	Rear Panel	27
11.0	Information Display Functions	29
11.1	Information Displayed	29
12.0	Operating the DewMaster	31
12.1	Information Display	31
12.1.1	Time and Date	31
12.1.2	System Status	31
12.1.3	Main Displays	32
12.1.4	Bar Graph	32
12.2	Programming the DewMaster	32
12.2.1	Keypad Operation	32
12.2.2	Scroll Menu	33
12.2.3	Display Setup	33
12.2.4	Sample Averaging	34
12.2.5	Analog Output	35
12.2.6	ABC Cycle	35
12.2.7	Alarm Relay	33
12.3	Programming the Serial Port	36
12.3.1	Serial Output	36
12.3.2	External Device Connections	36
12.3.3	PC or Terminal Setup	36
12.3.4	RS-232 Commands and Parameters	36
13.0	The Chilled Mirror Dew Point Sensor	42
13.1	Theory of Operation	42
13.2	Mirror Automatic Balance Cycle (ABC)	43
13.3	Care and Maintenance of the Chilled Mirror Sensor	44
14.0	Maintenance	45
14.1	Routine Maintenance	45

14.2	Mirror Cleaning Schedule	45
14.3	Mirror Cleaning	46
14.4	Understanding ABC and Mirror Messages	46
14.5	Sensor PRT Calibration Check	47
14.5.1	Performing the PRT Calibration Check	47
14.6	Servo Gain Adjustment	47
14.7	Display Contrast Adjustment	48
14.8	Replacing the Fuse	48
14.9	Air Filter Replacement (if used)	48
14.10	Modifying the Analog Outputs	49
15.0	Specifications	50

<b>2.0 LIST OF ILLUSTRATIONS</b>		<b>Page</b>
3-1	DewMaster Chilled Mirror Dew Point Hygrometer	8
8-1	Typical Sampling System	19
8-2	Typical Sample Line Material Characteristics	20
8-3	Flow Corrections for Various Pressures	22
8-4	Flow Corrections for Various Gases	23
9-1	Basic Block Diagram	24
10-1	DewMaster Front Panel	26
10-2	DewMaster Rear Panel	27
11-1	The Information Display	29
12-1	Keypad	33
12-2	Programming the Current Date	34
12-3	Setting the Analog Output Range	34
12-4	Programming the Alarm Relay Setpoint	35
12-5	Locking In the Programming Changes	35
13-1	Chilled Mirror Block Diagram	42
14-1	Cleaning the Mirror	46
14-2	Replacing the Fuse	48
14-3	Analog Mode Switches	49

## 3.0 INTRODUCTION

### 3.1 GENERAL DESCRIPTION

The DewMaster Dew Point Hygrometer (Figure 3-1) is a microprocessor based, programmable humidity measurement instrument with many microprocessor controlled features built-in.

Using the highly accurate Optical Chilled Mirror (OCM), primary dew point measurement technique, the DewMaster was developed for process control and continuous unattended operation as well as laboratory and research applications. Three sensors are available, with a depression of either 45°C (S1 Sensor), 65°C (S2 Sensor), or 95° (S3 Sensor) from an ambient temperature of 25°C. The system can measure frost points as low as -75°C (1 PPMv) with the S3 Sensor and auxiliary cooling.

Figure 3-1. DewMaster Chilled Mirror Dew Point Hygrometer



### 3.2 SYSTEM OVERVIEW

The basic DewMaster system consists of a Control Unit and the S1, S2, or S3 Dew Point Sensor. The Control Unit has a menu driven LCD graphics display, parameter averaging, Automatic Balance Cycle (ABC), one analog output, one alarm relay and a RS232C serial port.

Optional features include an Ambient Temperature Probe, three Analog Outputs, two Form C Alarm Relays, and a live pressure input. The backlit LCD can display up to three user-selected parameters simultaneously.

Available readout parameters include Dew Point (C or F), Ambient Temperature (C or F), PPMv, Wet Bulb, Grains/lb, and Pressure in PSI. All measured, as well as all calculated values can be displayed as a rolling average from one to sixteen samples at a one sample-per-second rate. A hierarchical menu structure driven by “soft keys” provides a user-friendly method of choosing display options and setting limits and functions from the front panel.

The Automatic Balance Cycle (ABC) can be set to calibrate the sensor optics at preset times and intervals or can be initiated manually at any time.

Each analog output is available on the rear panel as 0 to 5 VDC or 4 to 20 mA and can be set to follow any parameter with individually adjustable high and low limits. The outputs can be set to TRACK the Dew Point temperature during the ABC cycle or HOLD the last value prior to the ABC cycle. The half duplex configured RS232C serial port can be used to set up functions, control the operation, and output data to a data-recording device.

### **3.3 DEW POINT SENSOR**

The Dew Point sensor has a chromium plated mirror to provide superior corrosion and abrasion resistance. The sensor is normally mounted on the instrument rear panel, but it can be mounted remotely up to 75 meters (250 feet) from the instrument by using the optional Remote Cable Mount kit.

Each sensor is equipped with a built-in cooling jacket to extend the measurement range to lower dew/frost points. The S2 Sensor has a depression range of 65°C (117°F) at a base temperature of 25°C and the S1 Sensor has a depression of 45° C (81°F). The S3 Sensor has a depression of 95°C (171°F) and comes equipped with two cooling fans in addition to the cooling jacket. The response time is as high as 1.5°C (2.7°F) per second at dew points above 0° Celsius. A spin-off cover permits easy access to the mirror for cleaning without the need of tools or disconnecting sample lines.

### **3.4 CONTROL UNIT**

The DewMaster Control Unit operates entirely under microprocessor control. State-of-the-art software provides the opportunity to include a flexible, informational, and user friendly interface. The Information Display and the Keypad are the only items on the front panel. Setup and operation of the Control Unit can be programmed via the front panel keypad or the RS-232 serial port.

## **3.5 INSTRUMENT OPTIONS**

### **3.5.1 Measured Parameters**

The basic unit measures Dew Point. Optional parameters include Ambient Temperature, RH, PPMV, Gr/lb, and Wetbulb. Consult the factory for additional parameters.

### **3.5.2 Analog Outputs**

Two additional outputs, for a total of three programmable, 0 - 5 VDC or 4 - 20 mA channels. See the Maintenance section for a description of the internal programming switches to change from voltage to current outputs.

### **3.5.3 Alarm Relay**

A second relay option provides an additional Form C (SPDT) relay which can be independently set for a high or low limit on any measured parameter. When an alarm condition occurs, the relay activates and a flashing message appears on the display also. The alarm conditions can be set up via the front panel or the RS232 serial port.

### **3.5.4 Pressure**

The live pressure sensor option enables the measurement of pressure-dependent variables such as PPMV or GR/lb. Standard ranges are 0 - 25 PSIA and 0 -100 PSIA. Consult the Factory for the measurement of other pressure-dependent variables.

## **3.6 AVAILABLE ACCESSORIES**

### **3.6.1 Remote Sensor Mounting Kit**

When it is required to locate the sensor remotely from the control unit, the optional Remote Mounting Kit must be used. This kit consists of the mounting hardware, connectors, and cable necessary for locating the sensor remotely. The standard cable length is 10 ft., however, optional custom lengths up to 75 meters (250 feet) can be ordered.

### **3.6.2 Available Sample Line Filters**

- In-line Sample Filter
- In-line Coalescing Filter

### **3.6.3 Sample Module Kit**

The Sample Module Kit consists of a free piston vacuum pump and a variable area flow meter, housed within a NEMA-4X enclosure. The pump can be supplied to operate on either 115 VAC or 230 VAC  $\pm 10\%$ , 50 to 60 Hz input power.

## **4.0 WARRANTY STATEMENT**

All equipment manufactured by Edgetech Instruments Inc. is warranted against defective components and workmanship for repair at their plant in Massachusetts, free of charge, for a period of twelve months. Malfunction due to improper use is not covered in this warranty and Edgetech Instruments Inc. disclaims any liability for consequential damage resulting from defects in the performance of the equipment. No product is warranted as being fit for a particular purpose and there is no warranty of merchantability. This warranty applies only if (i) the items are used solely under the operating conditions and in the manner recommended in the instruction manual, specifications, or other literature; (ii) the items have not been misused or abused in any manner or repairs attempted thereon; (iii) written notice of the failure within the warranty period is forwarded to Edgetech Instruments Inc. and the directions received for properly identifying items returned under warranty are followed; and (iv) the return notice authorizes Edgetech Instruments Inc. to examine and disassemble returned products to the extent Edgetech Instruments Inc. deems necessary to ascertain the cause for failure. The warranties expressed herein are exclusive. There are no other warranties, either expressed or implied, beyond those set forth herein, and Edgetech Instruments Inc. does not assume any other obligation or liability in connection with the sale or use of said products. Equipment not manufactured by Edgetech Instruments Inc. is supported only to the extent of the original manufacturer's warranties.

## **5.0 EDGETECH INSTRUMENTS INC.'S COMMITMENT TO QUALITY**

To Our Customers:

Thank you for purchasing one of our products. At Edgetech Instruments Inc., it is our policy to provide cost-effective products and support services that meet or exceed your requirements, to deliver them on time, and to continuously look for ways to improve both. We all take great pride in the products we manufacture.

We want you to be entirely satisfied with your instrument. The information contained in this manual will get you started. It tells you what you need to get your equipment up and running, and introduces its many features.

We always enjoy hearing from the people who use our products. Your experience with our products is an invaluable source of information that we can use to continuously improve what we manufacture. We encourage you to contact or visit us to discuss any issues whatsoever that relate to our products or your application.

*The Employees of Edgetech Instruments Inc.*

## **6.0 N.I.S.T. TRACEABILITY – WHAT DOES IT MEAN?**

This precision measuring instrument is certified by Edgetech Instruments Inc. to be traceable to N.I.S.T., the National Institute of Standards and Technology (formerly known as the National Bureau of Standards, or NBS), in Gaithersburg, Maryland, U.S.A. You have received a Certificate of Calibration with this instrument. What does N.I.S.T. Traceability mean in terms of this instrument?

The instrument measures Dew Point using the Optical Chilled Mirror (OCM) technique, which provides a primary rather than a secondary measurement of Dew Point temperature. In addition, Dew Point is a fundamental measurement of humidity. It is not affected by temperature.

The Dew Point temperature is measured using a Platinum Resistance Thermometer (PRT). This device is a coil of nearly pure platinum, where the rate of change of resistance with temperature is precisely known. Resistance is accurately measured and is automatically converted to temperature information within the instrument.

### **TRACEABILITY:**

- 1. The precise platinum resistance thermometer is N.I.S.T. traceable by the traceable resistance standards maintained by the PRT manufacturer.
- 2. A multi-point Dew Point calibration is performed on every chilled mirror sensor, using Edgetech Instruments Inc.'s traceable secondary dew point standard. This instrument, a precise chilled mirror hygrometer, is periodically sent directly to N.I.S.T. for certification against the USA's Dew Point transfer standard, a Two-Pressure Generator.

## 7.0 GLOSSARY

ABC:	Automatic Balance Control – a method of maintaining accuracy in the presence of contamination and minimizing maintenance requirements.
Analog Out	A voltage or current that tracks changes in a measured parameter.
AT	Air Temperature or Ambient Temperature
Depression	The magnitude of available mirror cooling in the chilled mirror sensor.
DP	Dew Point Temperature – the temperature that moisture in the air <i>just begins</i> to condense on a cooled surface.
Hold	Analog output which holds the last humidity reading just before the ABC cycle.
Hysteresis	The tendency of a sensor to give one set of readings when going up, and a different set of reading when going down.
Mirror	A small metallic reflective surface within the dew point sensor.
RH	Percent Relative Humidity – the ratio between the <i>actual</i> moisture content in the chamber and the <i>maximum</i> moisture content if the chamber air was saturated, at a given air temperature.
RS-232	An accepted industry standard for a serial digital interface.
Serial Port	See RS-232.
Servolock™	A method of indicating that the system is locked on and tracking the dew point.
Slew Rate	The rate of temperature change of the mirror assembly in the chilled mirror dew point sensor.
Track	Analog output which follows (tracks) the mirror temperature during the ABC cycle.

## **8.0 INSTALLATION**

### **8.1 UNPACKING**

Remove the DewMaster Dew Point Hygrometer from its shipping carton and remove any shipping ties, clamps, and packing material. Save the Certificate of Calibration shipped with this manual. Locate and save the small box containing the Cleaner Kit included in the shipping carton. The Model S1, S2 or S3 sensor is normally attached to the DewMaster Control Unit, except when the optional Remote Mounting Kit is ordered.

### **8.2 CONTROL UNIT INSTALLATION**

#### **8.2.1 CONTROL UNIT PLACEMENT**

Install the DewMaster in locations where the ambient temperature will not exceed the specified ambient temperature range.

Sensors are often specified to have a wider temperature operating range than the control unit. When the anticipated operating range of the sensor is expected to be outside the operating temperature range of the instrument, the sensor should be removed from the instrument and mounted remotely by means of the optional Remote Mounting Kit.

Always maintain the sensor temperature at least 5°C above the dew point temperature of the gas being measured. This prevents unwanted condensation on the inside of the sensor body. In addition, it supports proper operation of the heat pump control circuit.

#### **8.2.2 WIRING CONNECTIONS**

Connect the DewMaster control unit to a grounded, instrument quality power source of between 95 to 240 VAC, 50 - 60 Hz.

**Note:** See correct power line fuse values in Specifications section.

You may wish to wire the Analog Output and Alarm Relay connectors. Connection information is clearly shown on the rear panel of the DewMaster. Specifications for the Serial Port, and also the Alarm Relay contact ratings, are in the Specifications section.

### **8.3 SENSOR SETUP FOR ACCURATE DEW POINT MEASUREMENTS**

#### **8.3.1 SAMPLE CONNECTIONS**

A basic requirement of accurate dew point measurements is the proper design of the gas sampling system. In order to measure the moisture content of a gas, the sampling system design must consider the effects of the

materials used, the sample pressure and flow rate, the range of dew points to be measured, and ambient conditions.

Generally, for dew point temperatures above  $-18^{\circ}\text{C}$ , the selection of sample line materials is not critical. It is only necessary to ensure that the temperature and pressure ratings are adequate to handle the sample, and that the connections are gas tight. For dew point temperatures below  $-18^{\circ}\text{C}$ , some attention must be given to the selection of materials in the sample system. Tubing material, for example, should be hydrophobic in nature, such as copper or stainless steel. Refer to subsection 8.3.5, Selection of Components.

Dew point is a measurement of the partial pressure of water vapor in a gas. Increasing the total pressure of the gas increases the partial pressure of each of its constituents, raising the dew point. See subsection 8.3.9, Pressure Measurements.

It is essential that the temperature of sampling components not be allowed to drop below the dew point temperature of the sample. This prevents condensation from occurring within the line, causing an erroneous measurement. Sampling lines and the sensor must be properly preheated when measuring dew points above ambient temperature. Refer to Preheating Sensor and Sample Lines, subsection 8.3.4.

In general, the most common problem areas that affect the moisture measurement of a sampled gas are:

1. Length of the process and/or sample lines.
2. Leaks in the process and/or sample lines.
3. Adsorption or absorption of moisture in the process and sample lines due to the materials.
4. Excessive elbows, tees, valves, or other fittings used in the sample lines.
5. Back diffusion of moisture into a pressurized system, particularly at low dew/frost points.
6. Condensation within the process line and sample line at high dew points.
7. Diffusion through the sampling materials.

The procedures and parts recommended in this manual should be used only as a guide in selecting and designing sampling systems. For special or unique applications, contact an Edgetech Instruments Inc. Application Engineer for assistance in selecting sampling components.

### **8.3.2 COOLANT CONNECTIONS**

For most applications, the Model S1, S2 or S3 sensor does not need cooling

of the sensor base. Since depression is measured relative to the temperature of the sensor base, cooling the base will lower the minimum dew point attainable. The sensor base can be cooled by supplying a liquid coolant to the integral coolant jacket. The coolant can be ordinary tap water, chilled water, or a chilled antifreeze solution such as ethylene glycol or methanol. Because of lower efficiency of the thermoelectric cooler at lower operating temperatures, depression decreases by 1°C for every 3°C of base temperature decrease. Therefore, the net decrease in minimum dew point if the base were cooled by 12°C would be 8°C.

Coolant flow rates of 0.25 GPM (1 LPM) are adequate, and the coolant pressure maximum rating is 100 psia (70 kg/cm<sup>2</sup>). Connections to the cooling jacket of the sensor requires ¼ inch hose and hose clamps.

#### **NOTES:**

1. When the coolant temperature is below the dew point temperature of the ambient atmosphere surrounding the instrument and sensor, condensation will form both on the surface and inside the sensor. Although this moisture will not harm the sensor, care should be taken to protect the instrument. In these cases the sensor should be unfastened from the rear of the instrument and operated away from the control unit. The optional Remote Mounting Kit allows the sensor to be located away from the instrument.

2. Please note that the specified depression range of a sensor is *not the same* as the actual measurement range. The measurement range is always a few degrees less at the low end, since the sensor cannot control at a dew point when it is “bottomed out”, or in the Max Cool condition.

#### **8.3.3 SAMPLING CONFIGURATIONS**

A suggested sampling system for use with the DewMaster Dew Point Hygrometer is shown in Figure 8-1. A portion of the gas line to be sampled is brought to the hygrometer from a pressure tap, either by using a suitable vacuum pump or by returning the sample to a lower pressure point. The flow rate through this main sampling line should be sufficient to allow fast response times for the sampling system.

A bypass line may be used to increase the main sampling line flow rate thereby improving the overall response time. It is necessary that the main sampling line be equipped with a valve for adjusting the sample flow rate. The hygrometer’s gas sample is obtained from the pressure drop across the bypass as shown in Figure 8-1. A filter of 0.5 microns at the input to the sensor would reduce particulate contaminants and decrease mirror cleaning requirements.

Several sintered stainless steel types of suitable filters are listed under Recommended Hardware, in subsection 8.3.8 The filter is considered a hygroscopic element that will contribute some lag to the sampling system. In the design of hygrometer sampling systems, minimize the number of components such as valves, tees, and filters, prior to the Sensor input. The Sensor output should be connected to a suitable flow measuring device, such as a rotameter or valve to adjust the flow rate to the recommended range of 0.5 to 5.0 SCFH (14 to 142 LPH).

**NOTES:**

1. Excessively high sample flow rates may cause a loss in the depression capability and unstable operation of the system.
2. Considerable savings can be obtained by recognizing that the sample exhaust lines and related components need not be of as high a quality and as nonhygrophobic as those prior to the dew point sensor.
3. The gas to be sampled must be furnished to the 1/8-27 NPT male ports on the sensor. Flow may pass through the sensor in either direction.
4. A sample shut-off valve may be used on the input side of the sensor to extract the sample. Such a valve is especially useful when opening the sensor for periodic mirror cleaning, or when working with samples at high pressures.

**8.3.4 PREHEATING SENSOR AND SAMPLE LINES**

If the dew point of the gas under measurement is above the ambient temperature of the installation and sampling lines, both the lines and the Sensor must be preheated. The sample lines must be installed with heat tape or another means of maintaining an elevated temperature, so that condensation will not occur in the route to the sensor. The approach used will vary widely with the specific nature of the installation, and the user must ensure that no portion of the sample line is at a temperature lower than the highest dew point anticipated. If electrical heater lines are used, it is usually sufficient to connect them to a variable transformer to adjust the heating level. If the sample lines are long, it may be desirable to wrap them in insulation to minimize the amount of heat required for preheating. The sensor temperature must always be maintained at least 10°C above the dew point temperature of the gas sample. The temperature of the sensor must never exceed +100°C. Heating the sensor and sample lines above the dew point of the gas sample does not change the dew point of the sample.

**Note: Use of the optional Remote Mounting Kit allows the sensor to be easily heated.**

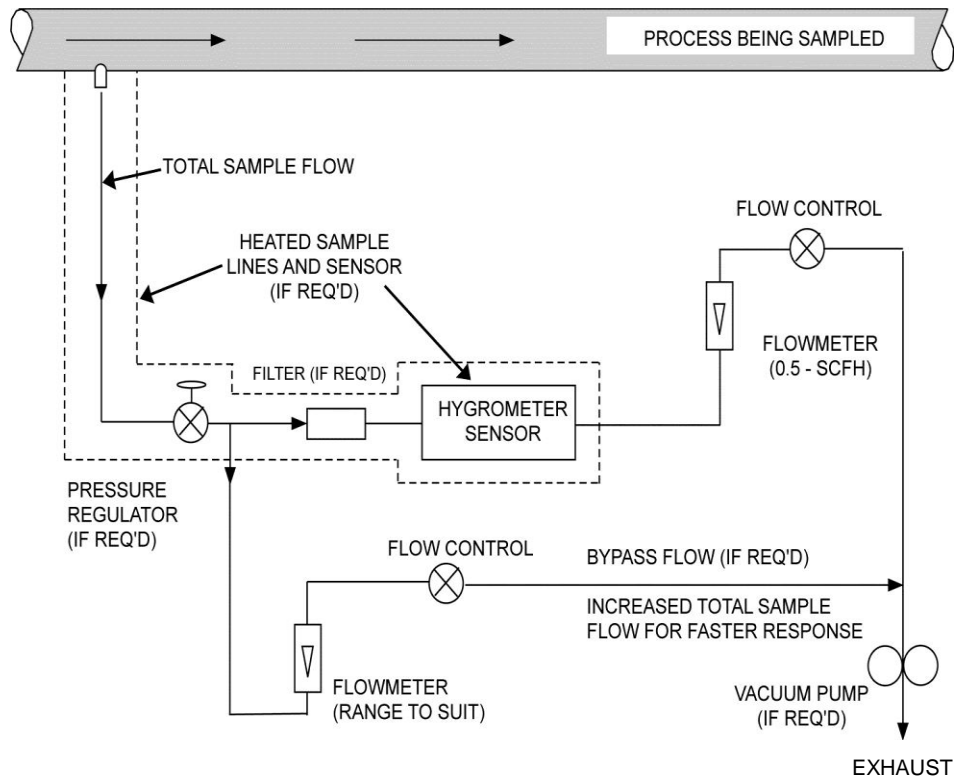

Figure 8 -1. Typical Sampling System

### 8.3.5 SELECTION OF COMPONENTS AT LOW DEW POINTS

When measuring dew points below  $-18^{\circ}\text{C}$ , increased attention to sampling details must be made as the dew point is lowered. Rubber, neoprene, tygon, and most plastic tubing are undesirable for use in sample lines. Non-hygroscopic materials such as stainless steel, copper, Impolene, Teflon, or KEL-F, with a minimum of joints, fittings, and other plumbing, is recommended. The actual selection of the sample line material should be based on the degree of permanency of the installation, and the type of fittings and connections to be used. Generally, stainless steel is preferred for permanent installations operating at low dew points. On stainless steel lines, either swage or flare-type fittings can be used. Leaks in the sampling system must be avoided, particularly for installations operating below atmospheric pressures, since leakage of ambient air into the sampling system will seriously offset the readings obtained.

### 8.3.6 MATERIAL MOISTURE PROPERTIES

All materials will absorb moisture to some extent. The adjacent curves shown in Figure 8-2 relate typical desorption properties of common sampling line materials after being exposed to a "wet" gas such as the ambient atmosphere. The curves illustrate the difficulty of obtaining a fast system response when switching from a high dew point sample to a low dew point

sample. Even if the instrument were to respond instantly, the sampling lines would dictate the overall response.

### 8.3.7 SELECTION OF SAMPLING PUMPS

Three types of pumps are generally suitable for hygrometric work. For installations where the sample is not to be returned to the process, the Gas Manufacturing Co. vane pump is acceptable. This pump offers a reasonably high degree of reliability and can handle large volumes of air. The vane type of pump tends to contaminate the sample with minute amounts of pump-wear by-products (iron, carbon); therefore, it should only be connected on the output side of the sensor.

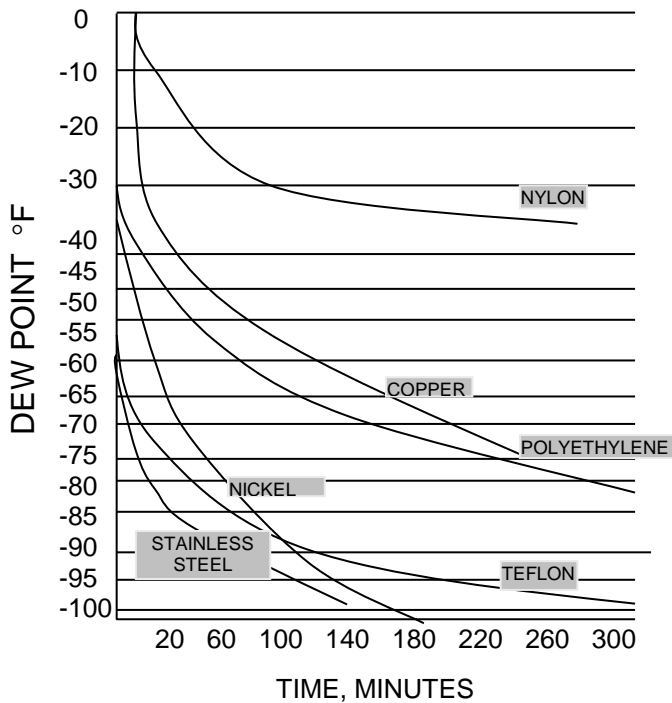

Figure 8 -2. Typical Sample Line Material Response Characteristics

For general-purpose use or for closed-loop sampling at atmospheric pressure, any one of several types of diaphragm pumps, such as the Neptune Dynapump, can be used. The Dynapump uses a neoprene diaphragm, and the pump housing is aluminum.

For most closed-loop sampling, where leak tightness is essential, the welded bellows type, such as the Metal Bellows MB-21, can be used. These pumps are available from Edgetech Instruments Inc. as well as from their respective manufacturers. (The optional Sample System Kit uses the Neptune Dynapump Model No. 2.)

### **8.3.8 RECOMMENDED HARDWARE**

#### **Pumps**

Carbon Vane Type:

Gast Mfg. Co. Model 0531-102B-347X (0.6 cfm) or equivalent.

Diaphragm Type:

Neptune Products Dynapump, Model 2 (2.25 cu. in./min.) or equivalent.

Bellows Type:

Metal Bellows Co. Model MB-21 or equivalent.

#### **Filters (General Purpose, In-Line)**

Stainless Steel:

NUPRO Model 4F-316, with 60-micron filter element, or equivalent.

Brass:

NUPRO Model 4F, with 60-micron filter element, or equivalent.

#### **Flow Gauges (with valves)**

Stainless Steel and Glass:

Brooks Sho-Rate "50" No. 1350-V, or equivalent. range 0.2-4.5 SCFH

Brass and Lucite:

Brooks-Mite No. 2001V, 0.1-4.5 SCFH

#### **Sample Tubing and Recommended Fittings**

Stainless Steel, ¼ in.:

Flare, Parker or Swagelok (use SS fittings)

Copper, ¼ in.:

Swagelok or Parker (use brass fittings)

Teflon (or Kel-F) ¼ in.:

Swagelok or Parker Stabilized Polypropylene

### **8.3.9 PRESSURE MEASUREMENTS**

The dew point temperature of a gas is a measure of the absolute moisture content of the gas, at a given pressure, regardless of the temperature of the gas. Most conversion tables for dew point (or frost point), to parts-per-million, grains-per-pound, etc., are made at atmospheric pressure (14.7 psia or 1.03 kg/cm<sup>2</sup>); therefore, if accurate absolute moisture content measurements are to be converted to atmospheric-pressure-referenced values, the pressure must be known. If dew points are to be measured at sample operating pressures other than atmospheric, the hygrometer sensor should be fitted with an appropriate pressure gauge.

**Caution: The maximum sensor pressure rating is 300 psia, or 21 kg/cm<sup>2</sup>.**

### **8.4 SOURCES OF CONTAMINATION**

Most types of metal tubing contain oil deposits on the interior walls due to the

manufacturing process. This residue must be removed before putting the lines into service in a gas sampling system. Trichloroethylene or similar degreasing solvent can be used to clean individual lines and components before assembly, with a final flushing after assembly. The lines should be purged dry with air or nitrogen before being placed into service. In addition to the initial installation, the process itself may constitute a source of contamination, and, in many applications, these are volatile hydrocarbons. An excellent fluid for purging and cleaning the instrument and/or the sample lines is Freon 114. This is a suitable solvent since it is capable of holding many hydrocarbons in solution, and it is highly volatile, nontoxic, not explosive, readily available, and will not attack common sampling materials.

### **8.5 SAMPLE FLOW RATE**

When setting sample flow rates at other than 1 atmosphere (1.03 kg/cm<sup>2</sup> or 14.7 psia), or when gases other than air are involved, use Figures 8-3 and 8-4 to convert the indicated sample flow rate reading to the actual flow rate.

Figure 8-3 gives the actual flow rate of air at pressures other than 1 atmosphere (14.7 psia). For example, the actual flow rate of air at 30 psia is 3.3 SCFH when the sample flow rate reading is 2.3 SCFH.

Figure 8-4 gives the actual flow rate of six different gases. The actual flow rate of helium, for example, when the sample flow rate indicates 1.2 SCFH is 3.3 SCFH (at 1 atmosphere). When gas pressures other than 1 atmosphere are used, use Figure 8-3 to convert the "actual" flow rate reading obtained from Figure 8-4 to the true flow rate. Using 30 psia, rather than 1 atmosphere in the helium gas example above, apply the 3.3 SCFH "actual" flow rate obtained from Figure 8-4 as the Flow Gauge Reading in Figure 8-3, and read 4.8 SCFH as the actual flow rate of helium at 30 psia.

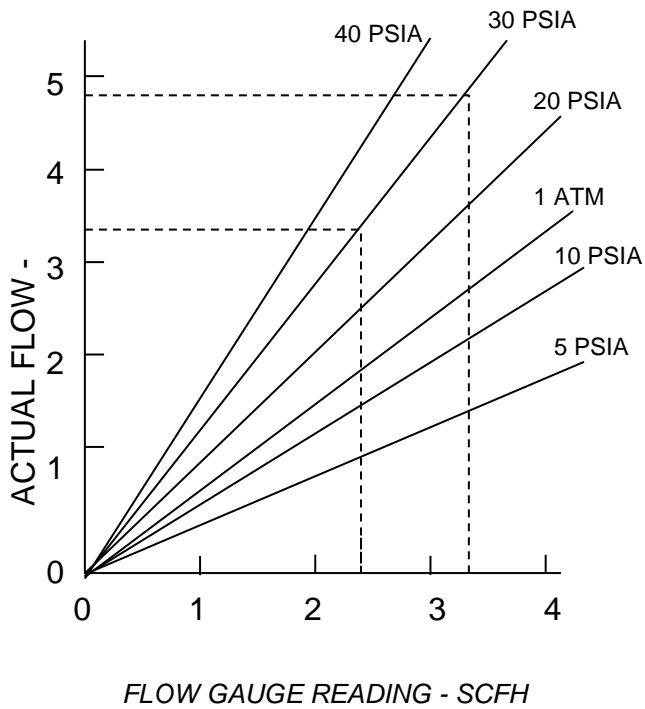

Figure 8-3. Flow Corrections for Various Pressures

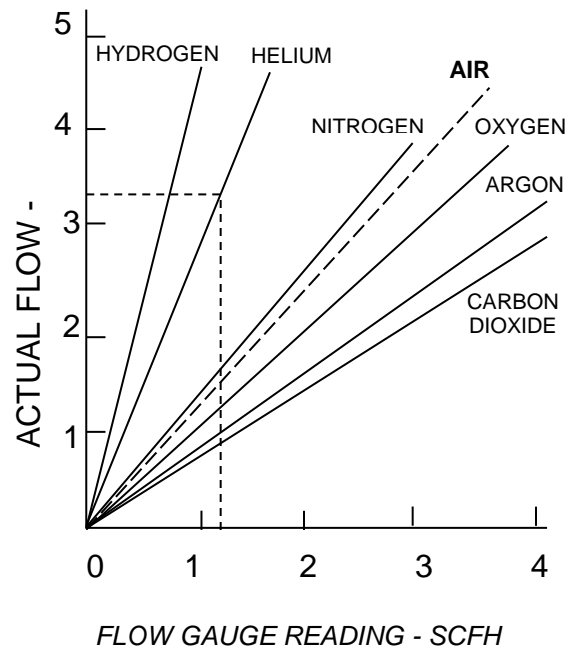

Figure 8-4. Flow Corrections for Various Gases

## 9.0 BASIC BLOCK DIAGRAM THEORY OF OPERATION

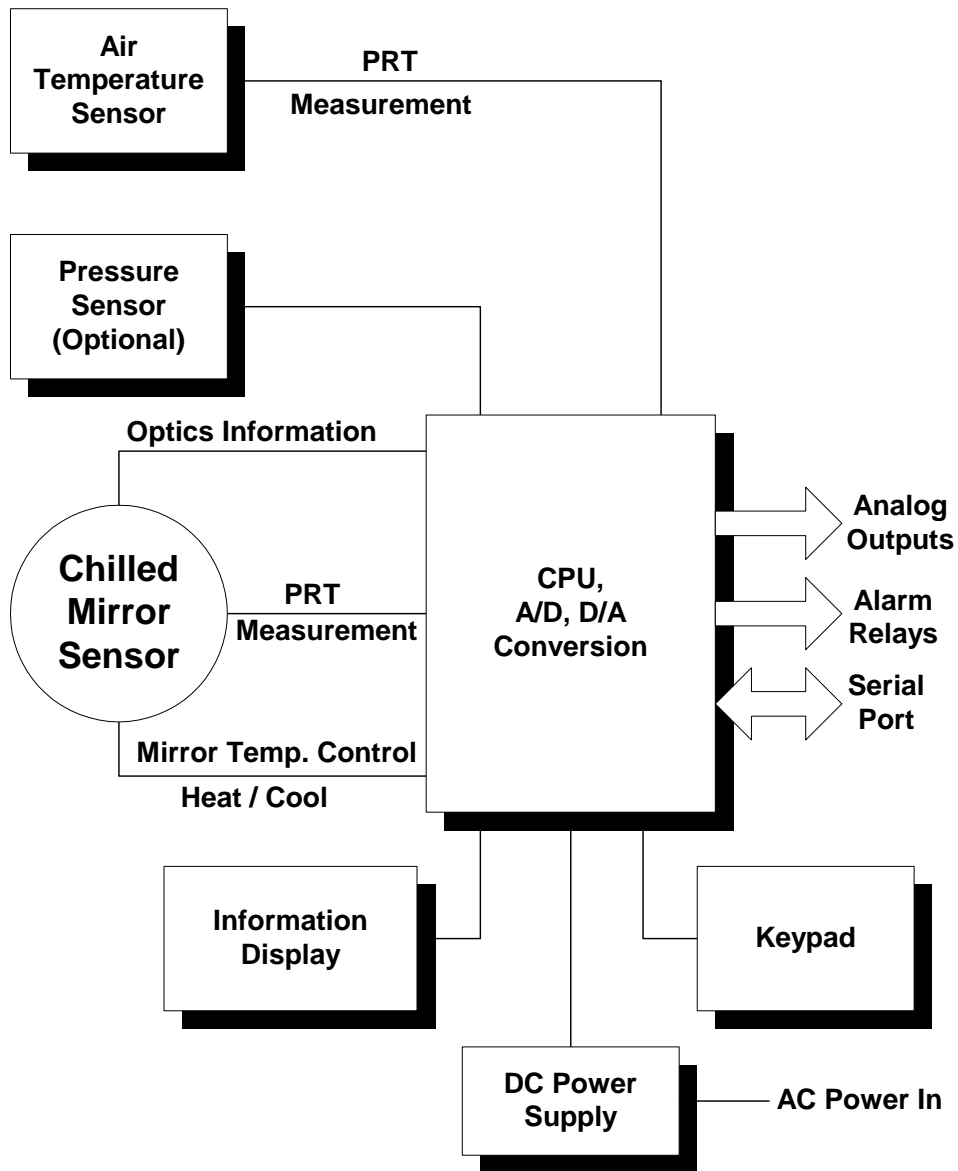

Figure 9-1. Basic Block Diagram

## 9.1 BASIC BLOCK DIAGRAM DESCRIPTION

See the Basic Block Diagram, Figure 9-1.

A one-stage (S1), two-stage (S2), or three-stage (S3) Chilled Mirror Dew Point Sensor is connected to the DewMaster. Although normally mounted to the rear panel, a remote mounting kit is also available. Dew Point information, in the form of platinum resistance thermometer (PRT) measurements, is provided to the CPU via an A/D converter.

An Air Temperature sensor, also using a PRT measurement, provides temperature information to the CPU.

An optional pressure sensor may also be used if desired.

The CPU, via Analog-to-Digital and Digital-to-Analog converters, supports the sensors and receives Dew Point and Temperature data. With these parameters, it can calculate and display Percent Relative Humidity information. If a Pressure sensor is added, the CPU also has information to display Parts of Water Vapor per Million Parts of gas, and other pressure-dependent variables.

The front panel mounted LCD Information Display with its three main displays, provides a visual interface with the user. It can be used to program such things as the displayed parameter sequence, alarm setpoints, and analog ranges, in conjunction with the Keypad. Real Time and Date is shown at the top. Also shown on the Information Display is a unique profile of the chilled mirror dew layer, allowing the user to gain insight into the finer points of chilled mirror sensor operation if desired.

The Keypad, also mounted on the front panel, is used to enter programming information to the DewMaster. It has soft keys allowing the initiation of heating or cooling of the dew point sensor mirror, and it can also initiate a manual ABC Cycle at any time.

Analog Outputs, either 0 to 5 VDC or 4 to 20 mA, (internally selectable) are provided on the rear panel. One Analog Output is standard, up to three may be had optionally.

Also provided on the rear panel is a SPDT (Form C) Alarm Relay. A second Alarm Relay is available as an option.

An RS232C Serial Port is rear panel mounted, allowing the DewMaster to communicate with a remote terminal or computer. All the programming that can be done with the Keypad may also be done with the remote device.

## 10.0 DESCRIPTION

### 10.1 FRONT PANEL

#### 1. CONTROL UNIT

#### 2. INFORMATION DISPLAY

#### 3. KEYPAD



Figure 10-1. DewMaster Front Panel

1. **Control Unit** – The Control Unit contains all the electronics to support the sensors, allow programming of units and other parameters, display user information, and allow microprocessor control of the system.
2. **Information Display** – The LCD Information Display can display up to three parameters simultaneously, real time and date, operational status, alarm conditions, sensor mirror condition, and alerts to user to fault conditions. The Display is backlit to enhance readability.
3. **Keypad** – The membrane type Keypad allows the user to enter setup and instrument control information. A Scroll Menu shown on the Information Display guides the user through the setup procedure. The setup parameters include Time, Date, Display, Digital Averaging, Analog Output parameter and scale, ABC start and interval, Alarm parameter, and Serial Port.

## 10.2 REAR PANEL

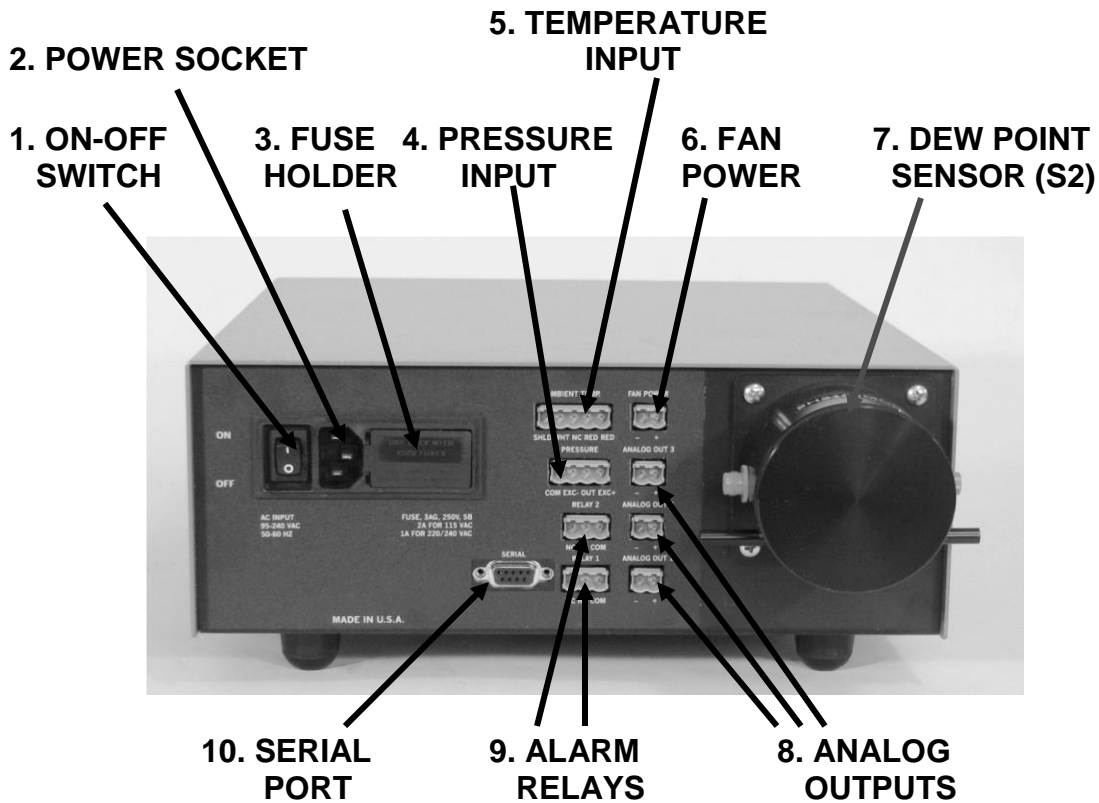

Figure 10-2. DewMaster Rear Panel

1. **ON-OFF Switch** – The Power Switch allows convenient control of AC Power to the DewMaster.
2. **Power Socket** – The AC Power cord plugs into the Power Socket.
3. **Fuse Holder** – The Fuse Holder allows convenient replacement of the AC Power fuse which protects the DewMaster from electrical damage.
4. **Pressure Input** – This connector allows the user to plug in an optional live pressure sensor. Pressure-dependent units such as PPMv, as well as actual pressure may now be read on the front panel Information Display.

5. **Temperature Input** – A Platinum Resistance Thermometer (PRT) may be connected to this socket, providing readouts of Ambient Temperature, as well as temperature-dependent calculated parameters such as Percent Relative Humidity (RH).
6. **Fan Power** – This socket provides power to optional air-cooled dew point sensors such as the three-stage Model S3.
7. **Dew Point Sensor** – A one-stage, two-stage, or three-stage chilled mirror dew point sensor is normally rear panel mounted as shown. An optional Remote Mounting Kit is also available.
8. **Analog Outputs** – One Analog Output, either 0 to 5 VDC or 4 to 20 mA, is available at the rear panel. There is an option for three sets of Analog Outputs. Each output can be set to track any parameter, and may be independently scaled using the Scroll Menu or through the Serial Port.
9. **Alarm Relays** – One programmable Form C (SPDT) relay is provided to control external valves or other devices. An option for two Alarm Relays is available. The alarm setpoints can be set independently for parameter, value, and high or low activation with the Scroll Menu or through the Serial Port.
10. **Serial Port** – The RS-232C Serial Port can be used to remotely program desired parameters, initiate an ABC Cycle, or output data to a local or remote terminal, printer, or computer. The data output function provides the date, time, up to three selected parameters, and system status to an RS-232C equipped serial device. The data can be sent on a command from the external device, or sent automatically at programmed intervals.

## 11.0 INFORMATION DISPLAY FUNCTIONS



Figure 11-1. The Information Display

### 11.1 INFORMATION DISPLAYED

THE LARGE LCD Display mounted on the Front Panel provides the user with all the information necessary to properly operate the DewMaster. It can be used as the primary interface with the instrument, showing status of all parameters, and allowing settings to be easily programmed by using the Keypad.

#### NOTES:

1. The RS-232 Serial Port, along with a computer or terminal, may also be remotely used for programming the DewMaster.
2. All programming is in non-volatile memory, so that it is retained when power is off.
3. The real time clock continues to run when power is off, maintaining the correct Time and Date information.

## TOP ROW:

<b>DATE</b>	The current date
<b>TIME</b>	The current time
<b>CONTROL LOOP STATUS</b>	Shows Chilled Mirror Control Loop status

## CENTER ROW (MAIN DISPLAY):

<b>DEW POINT</b>	The actual measured Dew Point
<b>AIR TEMPERATURE</b>	The actual measured Air Temperature
<b>RELATIVE HUMIDITY</b>	The calculated Percent RH

### NOTES:

1. The three displays may be used to show any available parameter.
2. Temperature and Humidity information may be displayed in any desired sequence.

## BOTTOM ROW:

<b>BAR GRAPH DISPLAY</b>	The Bar Graph displays an actual picture of the dew layer on the chilled mirror surface. The right hand vertical bar indicates the mirror itself, and the white bars show the actual dew layer. The layer can be seen to vary in thickness as the control loop brings the mirror into control at the dew point. Then, a thin layer of dew is maintained on the surface as the mirror temperature tracks the dew point temperature.
--------------------------	--

## 12.0 OPERATING THE DEWMASTER

In order to operate this instrument, it is assumed that you have read the INSTALLATION section of this manual, and preliminary tasks have been done.

These include:

1. The instrument has been connected to a proper AC power source.
2. If desired, the Analog Outputs, Alarm Relays, and/or Serial Digital (RS-232) Output has been wired.
3. A dew point sensor sampling system, if needed, has been installed.

Note: For dry gases, allow sufficient time for the sampling system to dry out (outgas) before taking measurements. If moisture content is only a few parts-per-million, it may be advisable to dry it out overnight.

***If you have not checked these points, the INSTALLATION chapter should be reviewed before proceeding.***

Set the rear panel Power Switch to the ON position. The Digital Display will:

1. Light up
2. Briefly indicate "DEWMASTER by EDGETECH INSTRUMENTS INC."
3. Go into the normal display mode

### 12.1 INFORMATION DISPLAY

#### 12.1.1 TIME AND DATE

Real time information is displayed in the upper left corner of the main Information Display window. This is programmable via the keypad. It is in non-volatile memory with battery backup, so that the information will remain correct when instrument power is shut off and later turned on again.

#### 12.1.2 SYSTEM STATUS

The status of the DewMaster control systems may be seen in the upper right corner of the Display. When first turned on, it may read HEAT or STARTUP. At other times, it may read MAX HEAT, or ABC: HEAT, or ABC: STABLE, or SEEKING DP. After several minutes, the Display will

read SERVOLOCK. This is the normal operating condition, which indicates that the system is tracking the Dew Point. *Do not take measurements until the SERVOLOCK indication appears.*

### **12.1.3 MAIN DISPLAYS**

Across the center of the Information Display window are the three primary displays. They may be programmed to read any measurable parameter. For example, you may wish to display Dew Point, Gas Temperature, and Pressure (with optional pressure sensor) inside your process. In addition, the sequence of these displays is independently programmable.

### **12.1.4 BAR GRAPH**

Horizontally across the bottom of the Information Display window is the Dew Layer Bar Graph. The vertical bar on the far right of the graph indicates the actual chilled mirror within the dew point sensor. The white boxes to the left of the mirror bar indicate the thin dew layer maintained on the mirror while tracking the dew point. In other words, the bars provide a magnified picture of the mirror condition during sensor operation. Generally, the dew layer indication will take up approximately 2/3 of the bar graph.

## **12.2 PROGRAMMING THE DEWMASTER**

### **12.2.1 KEYPAD OPERATION**

DewMaster's front panel has six soft keys that support user set up and operation. The label for each key, and it's function, is described below.

<b><u>KEY</u></b>	<b><u>FUNCTION</u></b>
C/F	Toggles the displayed parameters, internal parameters and RS-232 output between degrees Fahrenheit and Centigrade. Thus it is important to choose operation in C or F <u>before</u> any other set-up activity.  Alarm values and output values are converted from Fahrenheit to Centigrade when the C/F soft key is pressed. The analog output level does not change when C/F is toggled, because ranges are converted.
MABC	Starts the Manual ABC cycle. If the DewMaster is already in an ABC cycle, this key cancels the ABC cycle.
HEAT	Turns on/off MAX HEAT. Once this key is pressed, the sensor is kept in MAX HEAT until the MAX HEAT soft key is pressed again. In the MAX HEAT mode, SERVOLOCK is bypassed and the mirror is heated. The upper right section of

the LCD flashes MAN MAX HEAT, and the RS-232 output indicates MAX HEAT. During an ABC cycle, MAX HEAT (MAX COOL) does not function.

**NOTE:** Turning on MAX HEAT turns off MAX COOL and vice versa. Both cannot be activated simultaneously.

- COOL Turns on/off MAX COOL. The sensor is kept in MAX COOL until the MAX COOL soft key is pressed again. The upper right portion of the LCD flashes MAN MAX COOL.
- ENT Enter to the SCROLL MENU.
- ESC Exit from the SCROLL MENU.

### 12.2.2 SCROLL MENU

The SCROLL MENU facilitates access to DISPLAY Setup, ANALOG Setup, ALARM Setup, ABC Setup, and SERIAL Setup.

In the SCROLL MENU, use the UP, DOWN, LEFT and RIGHT arrows to make your selection and then press the ENT key. The selected function will flash on and off and can now be set to the desired value using the keypad. Pressing the ENT key will stop the flashing and another function can be selected.



Figure 12-1. Keypad

Once all values have been set press the ESC key. The user will be prompted to accept all changes into non-volatile memory by pressing ENT, or reject them by pressing ESC. Either choice will return to the main DISPLAY. When entered in the SCROLL MENU, lack of activity on the keypad for 30 seconds will cause an exit to the main DISPLAY and no changes will be saved.

### 12.2.3 DISPLAY SETUP

Parameters to be viewed on the main DISPLAY: Left, Center, or Right, can be set in any order. In the SCROLL MENU enter a display box : L, C, or R, and use the up, down arrows to choose a parameter (or select none). Then press the ENT key.



Figure 12-2. Programming the Current Date

### 12.2.4 SAMPLE AVERAGING (1-16)

With Average set to 1, as each determination is made, it is shown on the display. With the Average set to 2, the two most recent determinations are added together and divided by 2, then displayed. With Average set to 16, the 16 most recent determinations are averaged together for display. If Average is set to 1, the fastest dynamic response is achieved. However, if there is some noise or artifact, it will be displayed. If Average is set to 16, since one determination is made per second, the most recent 16 seconds of data is averaged to provide each displayed value. If there is some random noise or small but irrelevant changes in dew point, setting Average to 16 will smooth out unwanted or irrelevant changes. This can help avoid false alarms.

### 12.2.5 ANALOG OUTPUT

Analog Output 1 is located on the rear panel. The SCROLL MENU is used to assign parameters to the analog output channel. The analog output (OUT1) is also scaled by selecting the low (LO) and high (HI) range. The output is factory set at 0-5 VDC. 4-20 ma requires a field modification. To change it, see Modifying the Analog Output in the Maintenance section.



Figure 12-3. Setting the Analog Output 3 (RH) Range

### 12.2.6 ABC CYCLE

The Automatic Balance Cycle (ABC) can be initiated manually at any time, or started at any specified time of day (ABC START), and repeated at regular intervals (ABC INTERVAL). The analog output can be programmed to track or HOLD the parameters during an ABC cycle and the alarm is automatically disabled. To program a periodic ABC from the SCROLL MENU the START function must be ON. If ABC HOLD is ON, the analog and serial outputs will be held at the values just prior to initiating the ABC cycle. The Display will contain the message "ABC HOLD". The hold will be released when the ABC cycle is complete and the instrument has stabilized back on the dew point.

### 12.2.7 ALARM RELAY 1

Alarm Relay 1 is located on the rear panel and can be set to operate at

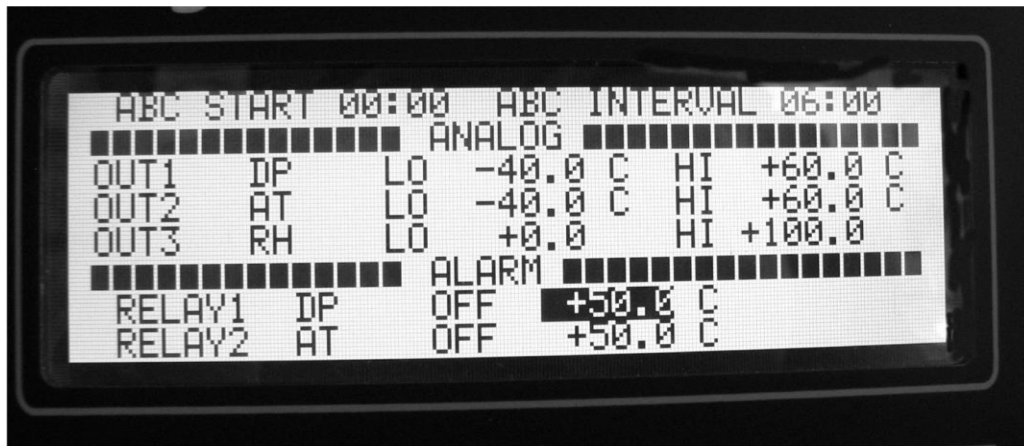

Figure 12-4. Programming the Alarm Relay 1 Setpoint

predetermined parameter limits. From the SCROLL MENU, the relay can be programmed to be off (OFF), to activate when the low limit is reached (LOW), or to activate when the high limit is reached (HIGH).



Figure 12-5. Locking In the Programming Changes

## **12.3 PROGRAMMING THE SERIAL PORT**

### **12.3.1 SERIAL OUTPUT**

The RS232-C serial port is located on the rear panel. To access serial communication it is necessary to have the Serial Enable on (ON), from the SCROLL MENU, and also to select the appropriate baud rate. The DewMaster serial port can be used to operate the unit, program parameters, or output data to a printer, data terminal, or personal computer. For bi-directional communications (such as with a PC or Terminal), a communication or terminal emulation software package is needed on the PC. There are many inexpensive communication programs readily available. Two such programs are HyperTerminal in Windows or PROCOMM PLUS by Quarterdeck/Datastorm Corp.

### **12.3.2 EXTERNAL DEVICE CONNECTION**

Connect an RS-232 cable between the DewMaster 9-pin female D-Type connector and the RS-232 serial port of the external device. All hardware handshaking lines are available at the connector; however a 3-wire XON/XOFF cable is all that is normally required. The serial port is wired as a DTE device (Data Terminal Equipment); i.e., Transmit (TXD) is pin 2 and Receive (RXD) is pin 3. Circuit common is pin 5. For connection to a DCE device (Data Communications Equipment) such as a PC, a direct pin-to-pin cable can be used. For connection to another DTE device such as a printer, a null modem adapter is required.

### **12.3.3 PC OR TERMINAL SETUP**

Set the DewMaster to the preferred baud rate via the SCROLL MENU. The available baud rates are 19.2K, 9600, 4800, 2400, and 1200. For optimum performance, the baud rate should be set to the highest rate that the connected device can accommodate reliably. Set up the PC's communication program for a baud rate to match the DewMaster. The protocol should be 8 data bits, 1 stop bit, and no parity (N81).

### **12.3.4 RS-232 COMMANDS AND PARAMETER SETTING**

#### **12.3.4.1 GENERAL**

Several of the setup and operating features of the DewMaster are available via the serial port. Commands can be upper or lower case. When any key is pressed, the DewMaster will respond with "Input: " and the key that was pressed "key". If the command is a single key command, pressing ENTER will initiate the command. For a two key command, press the second letter and then the ENTER key to initiate the command.

#### **12.3.4.2 HELP MENU**

Once communication has been established, the available commands can be viewed by accessing the HELP menu.

Type the letter "H". The display will reply with INPUT: H. Press ENTER and the HELP menu as shown in Table 12-1 will be displayed on the screen.

**Table 12-1 HELP MENU**

<u>COMMANDS</u>	<u>EXAMPLES (Max Entries Shown)</u>
Start a Manual ABC Cycle .....	AB <CR>
ABC enable toggle .....	AE <CR>
ABC Start Time (HH:MM) .....	AS <CR> 23:59 <CR>
Analog Hold Toggle (on/off).....	AH <CR>
ABC Interval (HH:MM).....	AI <CR> 23:59 <CR>
Alarm 1 (> or <) (Deg) (param) .....	AL1 <CR> > 100.0 7<CR>
Alarm 2 (> or <) (Deg) (param) .....	AL2 <CR> < -100.0
7<CR>	
Analog 1 Output (Min) (Max) (param) .....	AO1 <CR> -100 100
7<CR>	
Analog 2 Output (Min) (Max) (param) .....	AO2 <CR> -100 100
7<CR>	
Analog 3 Output (Min) (Max) (param) .....	AO3 <CR> -100 100
7<CR>	
Average (Number of Data Points) .....	AV <CR> 16 <CR>
Enter New Date (MM/DD/YY) .....	D <CR> 12/31/99 <CR>
Latch Alarm1 Toggle ON/OFF .....	L1 <CR>
Latch Alarm2 Toggle ON/OFF .....	L2 <CR>
Max Heat Toggle ON/OFF.....	MH <CR>
Max Cool Toggle ON/OFF .....	MC <CR>
Output Interval RS232 (Secs).....	O <CR> 3600 <CR>
Poll for Parameters.....	P <CR>
Display a Status Report.....	ST <CR>
Enter New Time (HH:MM:SS) .....	T <CR> 23:59:59 <CR>
Temperature Units (F, C).....	U <CR> C <CR>

*Press ENTER to continue.....*

**Notes:**

When a 'param'(parameter) entry is required, each parameter has a numeric value as follows: DP (Dew Point) = 1; AT (Ambient Temperature) = 2; RH (Relative Humidity) = 3; PPMV = 4; Gr/lb = 5; PSIA = 6; PSIG = 7 and Wet Bulb = 8.

Whenever a setting is changed via the serial port, the serial output times are recalculated. Input characters are not case sensitive.

#### **12.3.4.3 START AN ABC CYCLE**

This command initiates an ABC cycle at any time. The cycle is the same as a programmed ABC cycle.

Type the letters “AB” and press the ENTER key.

#### **12.3.4.4 ABC ENABLE**

Type “AE” and then ENTER to alternately enable or disable the timed ABC function. The start time and interval settings will not be changed.

**NOTE:** Two digits must be used for each entry field.

#### **12.3.4.5 ABC START TIME**

Type the letters “AS” and press the ENTER key. Enter the time “Hours:Minutes” in 24 hr. format, and press the ENTER key.

Examples: “02:00”, is 2:00 AM: “14:30” is 2:30 PM.

#### **12.3.4.6 ABC INTERVAL**

Type the letters “AI” and press the ENTER key. Type the time in “Hours:Minutes” and press the ENTER key.

Example: If the ABC Start Time is 08:00 o'clock in the morning and the ABC Interval is 02:00, the first ABC cycle for the day would occur at 8:00 AM and every two hours thereafter.

#### **12.3.4.7 ABC ANALOG HOLD**

Typing the letters ‘AH’ will toggle the ABC Hold feature on or off. If ABC Hold is on, the analog and serial outputs will be held at the values just prior to initiating the ABC Cycle. The serial output will contain the message “ABC Hold”. The hold will be released when the ABC Cycle is complete and the instrument has stabilized back on the dew point.

#### **12.3.4.8 ALARM 1 AND (OPTIONAL) ALARM 2**

The alarm relays can be set to operate at predetermined parameter limits.

Each relay can be set as a high or low set point by use of the greater than “>” and less than “<” symbols.

Each relay can also be independently set to latch when the preset limit is exceeded. In the latch mode, the alarm will remain active even if the alarm condition returns to normal. To reset a latched alarm relay, press the “SETUP” key twice from the main screen. If the latch mode is not set, the relays will deactivate when the alarm condition is corrected. The front panel alarm indicators will flash to alert the operator of an alarm that has occurred.

To enter or change the alarm limits, type the letters "AL1" for alarm 1 or "AL2" for alarm 2 and press ENTER.

Enter the set point beginning with the > or < symbol followed by a space and the sign and value of the alarm limit, and the parameter number of the variable. When completed, press the ENTER key.

Examples:

> +22.3 1 sets relay number one to activate at a level greater than +22.3 degrees dew point (param 1)

< 25.0 3 sets relay number two to activate if RH (param 3) falls below 25%.

#### **12.3.4.9 ALARM 1 AND ALARM 2 LATCHES**

The alarms can be set to latch on an alarm condition by typing "L1" for alarm 1 or "L2" for alarm 2.

A latched alarm will not reset itself when the alarm condition is resolved but requires operator intervention to reset.

The L1 and L2 commands toggle the latch on or off. To reset a latched alarm, press the 'SETUP' key twice.

#### **12.3.4.10 NUMBER OF DATA SAMPLES TO AVERAGE**

This command sets the number of data samples to average. Data is sampled once per second. Therefore, a number of 4 would display a 'rolling average' for the last 4 seconds. The limits are 1 to 16 samples.

Type the letters "AV" and press the ENTER key. The DewMaster will respond with "Enter SETTING =." Type the two-digit value and press the ENTER key.

#### **12.3.4.11 ANALOG OUTPUT (LOW) (HIGH) (PARAM)**

This function sets the 0-5 volt or 4-20 ma (analog) lower and upper output ranges and the parameter for each of three output channels. The instrument range is -100 to +100°C (-148 to +212°F).

A plus (+) sign is not needed for positive temperature entries, but a minus (-) sign is necessary.

Type the letters "AO1" for channel one, "AO2" for channel two, or "AO3" for channel three, and press the ENTER key. Enter the limits with a minus sign first (if negative), then the lower limit, a space, the positive or negative upper limit, a space, and the parameter number.

Press the ENTER key to record the values.

Example:

Entering “-33 45 2” sets a low value of -33°, a high value of +45°, and a parameter of Ambient Temperature (2). The units, C or F, will be whichever is active at the time of the setting. If the units are changed later, all affected parameters will be set to the new units.

#### **12.3.4.12 DATE**

Type the letter “D” and then press ENTER.

The DATE format is: MONTH/DAY/YEAR

“01/01/00” = January 1, 2000

“12/31/99” = December 31, 1999

**NOTE:** Two digits must be used for each entry field and separated by a backslash character.

#### **12.3.4.13 OUTPUT INTERVAL**

This is the interval in seconds between automatic data output transmissions of the serial data output. The time range is from 0 to 3600 seconds.

Type the letter “O” and press the ENTER key. Enter the desired interval in seconds and press ENTER.

#### **12.3.4.14 POLL FOR OUTPUT**

This command requests the DewMaster to send serial data at any time and is independent of the automatic interval.

Type the letter “P” and press the “ENTER” key.

#### **12.3.4.15 MANUAL HEAT**

This command toggles the Sensor’s heater on or off. It can be initiated at any time and can be used to clear excessive moisture from the mirror in flooding situations.

Type the letters “MH” and press the ENTER key. The DewMaster will display a flashing MAN MAX HEAT and the temperature will rise. To turn off the MANUAL HEAT mode, enter “MH” again.

#### **12.3.4.16 MANUAL COOL**

This command toggles the Sensor’s cooler on or off. It can be used to test the maximum depression of the Sensor.

Type the letters “MC” and press the ENTER key. The DewMaster will display a flashing MAN MAX COOL and the temperature will decrease. To turn off the MANUAL COOL mode, enter “MC” again.

**NOTE:** After an extended period of time in the cool mode, excess moisture or frost will form on the mirror. It may be necessary to “Manually Heat” the mirror to shorten the drying time.

#### 12.3.4.17 TIME

Type the letter "T" and press ENTER.

The time format is: Hours:Minutes:Seconds. Hours is expressed in 24-hour military time.

Enter the desired time with colon delimiters:

Examples:

"00:00:00" = 12 midnight

"23:59:59" = 11:59:59 pm

#### 12.3.4.18 UNITS (F,C)

The DewMaster can display temperature in either Degrees C or Degrees F. The display and RS-232 data will reflect the selection.

Type the letter "U" and press ENTER. Type "C" or "F" and press ENTER.

#### 12.3.4.19 STATUS REPORT

This command gives the user a report of all of the current settings. To get a status report, do the following.

Type the letters "ST". The display will show: Input: ST

Press the ENTER key. The following sample status report will display.

#### DEWMASTER SYSTEM STATUS REPORT

ABC data:	State	Start Time	Interval	Hold
	ENABLED	0:00:00	2:00	OFF

ALARM data:	#	Item	Type	Value	Latch	State
	1	DP	HIGH	0.00 C	ON	READY
	2	AT	LOW	-5.00 C	OFF	ACTIVATED

ANALOG data:	#	Item	Low	High
	1	DP	-20.00 C	40.00 C
	2	DP	-40.00 C	60.00 C
	3	RH	25 %	75 %

DISPLAY data:	Left	Middle	Right	Average
	DP	PPMV	GR	4

SERIAL data:	Baud	Interval	State
	9600	1:00	ON

Press ENTER to continue or ESC to return to normal operation.

## 13.0 THE CHILLED MIRROR DEW POINT SENSOR

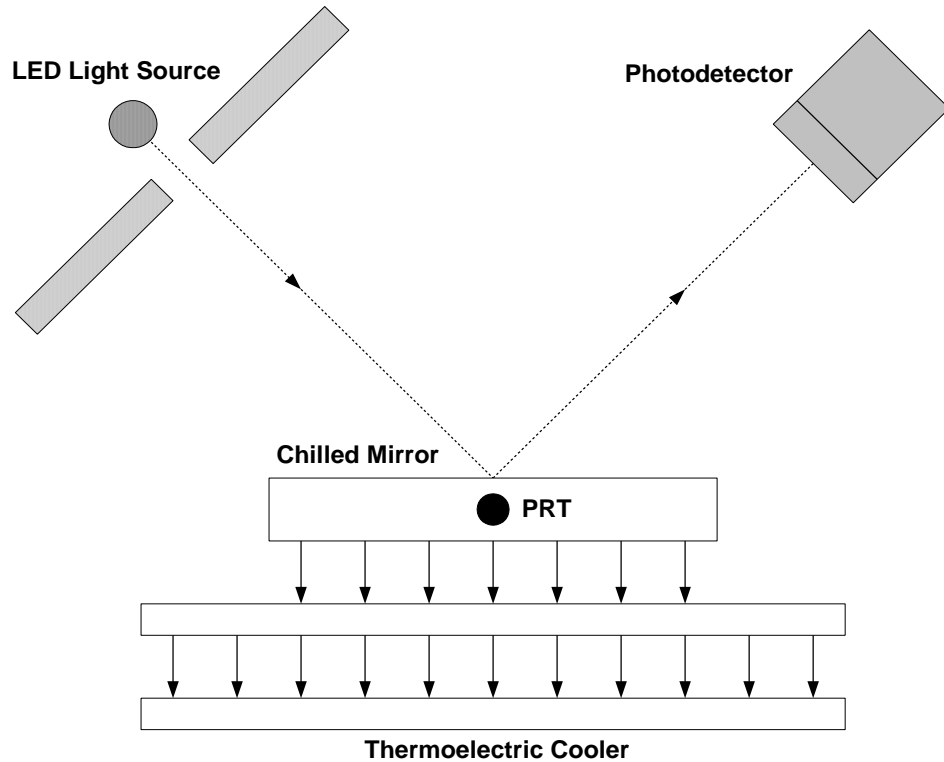

Figure 13-1. Chilled Mirror Block Diagram

### 13.1 THEORY OF OPERATION

Dew Point is defined as *the temperature that moisture just begins to condense on a surface*. The chilled mirror dew point sensor measures this parameter directly. A highly reflective stainless steel plated mirror is mounted to a solid state heat pump, or thermoelectric cooler. A light source (LED) is reflected off the mirror onto an opposing photodetector. The mirror is cooled thermoelectrically to the temperature at which condensation (dew or frost) first begins to form. This condensate causes the light from the light source to be scattered, resulting in a reduction of light as seen by the photodetector. This signal is sent to a servo amplifier which controls power to the thermoelectric cooler, automatically controlling the mirror at whatever temperature is required to maintain a very thin film of water droplets (or frost) on the surface at all times. This is the dew point (frost point when below 0°C) by definition.

Since the mirror surface is always at the dew point, measuring the mirror temperature provides actual dew point temperature. Temperature data is

received from a PRT (platinum resistance thermometer) embedded directly beneath the chilled mirror surface. The PRT is very tightly thermally coupled to the mirror surface, in order to minimize measurement error.

The advantages of the Chilled Mirror are:

- It provides a *primary*, as opposed to a *secondary* measurement of dew point.
- Measurement is continuous, accurate and repeatable.
- Results are traceable to N.I.S.T., supporting ISO 9000 and military test requirements.
- No hysteresis.
- No drift.
- Dew point accuracy of +/- 0.2°C

These advantages make the Chilled Mirror sensor the technology of choice for the Edgetech Instruments Inc. DewMaster.

### **13.2 MIRROR AUTOMATIC BALANCE CYCLE (ABC)**

The Automatic Balance Cycle is an important electronic feature of the DewMaster that allows much longer operation of the system without any maintenance. At least 90 days is typical. As contamination from the air sample gradually builds up on the mirror surface, an error in the indicated dew point reading could eventually occur. In order to eliminate this potential source of error, the system periodically reprograms itself by correcting for the loss in reflectivity caused by the contaminants on the surface, allowing the mirror to operate at the actual dew point temperature once again. This is called *balancing*. The user should always use the ABC feature, because it greatly minimizes mirror cleaning requirements.

When you first turn on the DewMaster, the Automatic Balance Cycle is initiated. It can also be programmed to be initiated automatically with selectable intervals, or initiated manually at any time by depressing the MABC (Manual Automatic Balance Cycle) key on the keypad. It can also be initiated remotely by using the RS-232 port.

The ABC first heats the mirror surface above the dew point, causing the condensate layer to evaporate, leaving only the contamination on the surface. The amount of light received from the dry mirror is then measured, and a correction in the servo loop is made, normalizing the system (balancing) and compensating for the contaminant layer. The balance cycle only takes a few minutes, and at the end of that period the mirror resumes tracking the actual dew point temperature.

TRACK and HOLD: The Analog Output can be programmed with the keypad to provide Humidity, Temperature, or optional Pressure information. When Dew Point is selected, (or Relative Humidity, which is a function of Dew Point and Temperature), the actual analog value is temporarily incorrect during the ABC. Since the mirror temperature is constantly measured and defined as the dew point, the heating of the mirror described above is the one time when the mirror temperature is intentionally *not* at the dew point. A keypad programming option allows the user to have the Analog Output remember the last dew point value *just before* the ABC started, and *hold* that value constant for the few minutes that the balance cycle requires. It then continues to track the actual real time dew point temperature (or RH) as before. This is the HOLD option, which may be the best choice when driving a strip chart recorder or when using a data acquisition system. If the TRACK option is selected, the resulting positive output pulse on the analog output during the heating portion of the ABC may be recorded and used to tell the operator when the cycle occurred.

### **13.3 CARE AND MAINTENANCE OF THE CHILLED MIRROR SENSOR**

Although the ABC greatly minimizes the requirement for mirror cleaning, eventually the system will have to be shut down and the mirror cleaned. A CLEAN MIRROR indication displayed at the end of the ABC tells the user when cleaning is required. See the Maintenance chapter for detailed instructions in mirror cleaning.

## 14.0 MAINTENANCE

### **CAUTION**

Removing the DewMaster Control Unit cover exposes the user to line operating voltages when the unit is connected to line power. Only experienced persons should attempt to make adjustments or tests with the cover removed. If the instrument is plugged in when performing any circuit adjustments or tests, take extreme care not to come in contact with the high voltage present around the power supply, the AC line filter, or the rear panel power switch.

### 14.1 ROUTINE MAINTENANCE

To ensure the maximum in accurate and reliable operation of any optical chilled mirror system, a periodic maintenance program should be established.

### 14.2 MIRROR CLEANING SCHEDULE

The buildup of contamination on the mirror surface normally occurs very slowly. Over time, particulates and other matter present in the sample gas and not captured by filters, build up on the mirror. The result of the buildup of contaminants on the mirror surface is reduced dry mirror reflectivity and a change in the optical reference point. The Automatic Balance Cycle (ABC) will automatically readjust the reference point periodically, but eventually the adjustment range will be exceeded and a manual cleaning of the mirror may be necessary. When the contamination becomes too severe to be adjusted automatically, an error will be displayed at the end of the ABC. Normally, intervals of 90 days between routine mirror cleanings can be easily achieved. However, if the sample contaminants are particularly high, more frequent mirror cleanings may be required. When cleaning is required, clean the mirror surface and the adjacent optical parts.

### **CAUTION!**

When operating with a pressurized sampling system, be sure to remove pressure from the Sensor prior to removing the Sensor cover.

## 14.3 MIRROR CLEANING

### To clean the mirror surface in the Sensor:

1. Remove the spin-off cover from the Sensor to expose the mirror.
2. Press the HEAT key on the front panel to heat the mirror and evaporate any condensate.
3. Cotton swabs and an empty cleaner bottle are provided in the Cleaning Kit shipped with the system. Fill the bottle with isopropyl alcohol, purchased locally. (We are not allowed to ship it). Moisten a clean cotton swab with the alcohol. Wipe the mirror surface and the optics surface in a circular motion.
4. After cleaning the mirror surface, wipe the surfaces dry with a clean cotton swab.
5. Next, moisten a clean cotton swab with clean, preferably distilled water and wipe the mirror and optics areas.
6. Dry these areas thoroughly with a clean, dry cotton swab.
7. Replace the sensor cover.
8. Press the HEAT key again to shut off the heat and allow the mirror to cool.
9. Press the MABC key to balance the optics and return to normal operation.



Figure 14-1. Cleaning the Mirror

## 14.4 UNDERSTANDING THE ABC AND MIRROR MESSAGES

The Automatic Balance Cycle (ABC) is initiated upon instrument turn-on. In addition, the ABC can be initiated automatically at programmable intervals, or initiated manually at any time by depressing the MABC (Manual Automatic Balance Cycle) key on the keypad, or remotely via the RS-232 port.

The ABC begins by heating the mirror to a temperature well above the dew point to evaporate any dew on the surface. The computer determines that the mirror is dry and ready to be re-balanced based on a pre-set time interval AND the stability of the mirror reflectance. The pre-set time interval is determined by the mirror temperature at the beginning of the cycle. At low temperatures, greater time is needed to heat the mirror and evaporate the condensate. If the mirror temperature at the beginning of the cycle is greater than  $-20^{\circ}\text{C}$ , the heat time is a minimum of 1.0 minute. If the temperature is below  $-20^{\circ}\text{C}$ , the heat time is a minimum of 3.0 minutes.

At the end of the heat phase, the computer balances the optical bridge and control loop and returns to normal operation. If, at the end of an ABC, the amount of balance adjustment is too large, a flashing "CLEAN MIRROR"

message will appear on the display and the serial output. See 14.3 above for detailed mirror cleaning instructions. If the computer finds any other abnormality in sensor performance during an ABC, a flashing “CHECK SENSOR” message will appear, in which case the factory should be contacted.

## **14.5 SENSOR PRT CALIBRATION CHECK**

Platinum Resistance Thermometers (PRTs) are used in the Dew Point Sensor and Air Temperature Probe. The accuracy has been factory calibrated and certified. However, if a problem is suspected, the accuracy can be checked using the PRT Calibration Check procedure.

### **14.5.1 PERFORMING THE PRT CALIBRATION CHECK**

1. A Precision Resistance Decade Box may be used to simulate the PRT in the Sensor.
2. Remove the top cover, and carefully unplug the large round Dew Point Sensor plug from its connector.
3. Set the resistance decade box to 100.00 ohms.
4. Using three equal lengths of the same gauge wire, connect pins 4 and 10 of the connector to each other and to one terminal of the decade box. Connect the other terminal of the decade box to pin 9 of the Sensor connector.
5. Turn instrument power on. The front panel display should read 00.0°C at this time.
6. Set the resistance decade box to 119.40 ohms. The display should read +50.0°C +/- 0.2°C.
7. Set the resistance decade box to 88.22 ohms, a display of -30°C +/- 0.2°C.
8. Once the check has been completed, remove the Resistance Decade Box and plug the Sensor back into the socket. Reinstall the Control Unit cover.

## **14.6 SERVO GAIN ADJUSTMENT**

The servo gain is adjustable with potentiometer **R73 “OPTICS GAIN”**. The adjustment affects the stability of the servo loop, particularly at high dew points. If the dew point is unstable or appears to oscillate, the gain may need to be decreased. A sluggish or slow response indicates a higher gain is required. The GAIN control adjusts the overall gain of the servo control loop. It is set at the factory to provide stable operation over the range of operation of the instrument. Before making adjustments to the GAIN control, always record the factory-set position to aid in returning to the original position at a later date.

1. Remove the top cover.
2. Rotate R73 clockwise to increase gain or counterclockwise to decrease.
3. Wait about a minute between adjustments to allow the servo loop to stabilize with the new gain.

4. Replace the top cover.

## 14.7 DISPLAY CONTRAST ADJUSTMENT

The display contrast is adjustable with potentiometer **R2** “**CONTRAST**”. The adjustment can be done in any operating mode.

1. Remove the top cover.
2. Adjust **R2** for the desired appearance.
3. Replace the top cover.

## 14.8 REPLACING THE FUSE

The AC power line fuse is located inside the right-hand portion of the AC Power socket assembly, in the upper left corner of the rear panel. For access, insert a small, flat screwdriver into the left side of the fuse holder, and pry the panel open. Then, pull the inner fuse holder assembly straight out. To close, reinsert the fuse holder assembly and snap the cover closed.



Figure 14-2a. Opening the Cover



Figure 14-2b. Fuse Holder Removed

## 14.9 AIR FILTER REPLACEMENT

If you are using an external air filter as part of your sampling system, replacement filter elements should be on hand. Depending upon the quantity of contaminants present in the incoming air, the filter element may need to be replaced periodically. A dirty element can cause several problems:

1. A clogged filter will slow down the sampling system response time.
2. The contaminants may be hygroscopic (porous to water molecules), causing the system to retain moisture and outgas for long periods of time.
3. If the vacuum pump is downstream of the sensor, a clogged upstream filter will cause a pressure drop in the sensor sampling system. This will result in an erroneously low dew point reading.

## 14.10 MODIFYING THE ANALOG OUTPUTS

The Analog Output connector is located on the rear panel. Output scaling is programmed by using the Keypad or through the Serial Port. The user may select 0 to 5 VDC, 4 to 20 mA, 0 to 20 mA, or 0 to 24 mA for these outputs. The factory default is 0 to 5 VDC. To change the outputs, it is necessary to remove the top cover and access three 4-pole DIP switches located inside. The DIP switches are mounted on the main printed circuit board, near the rear panel.

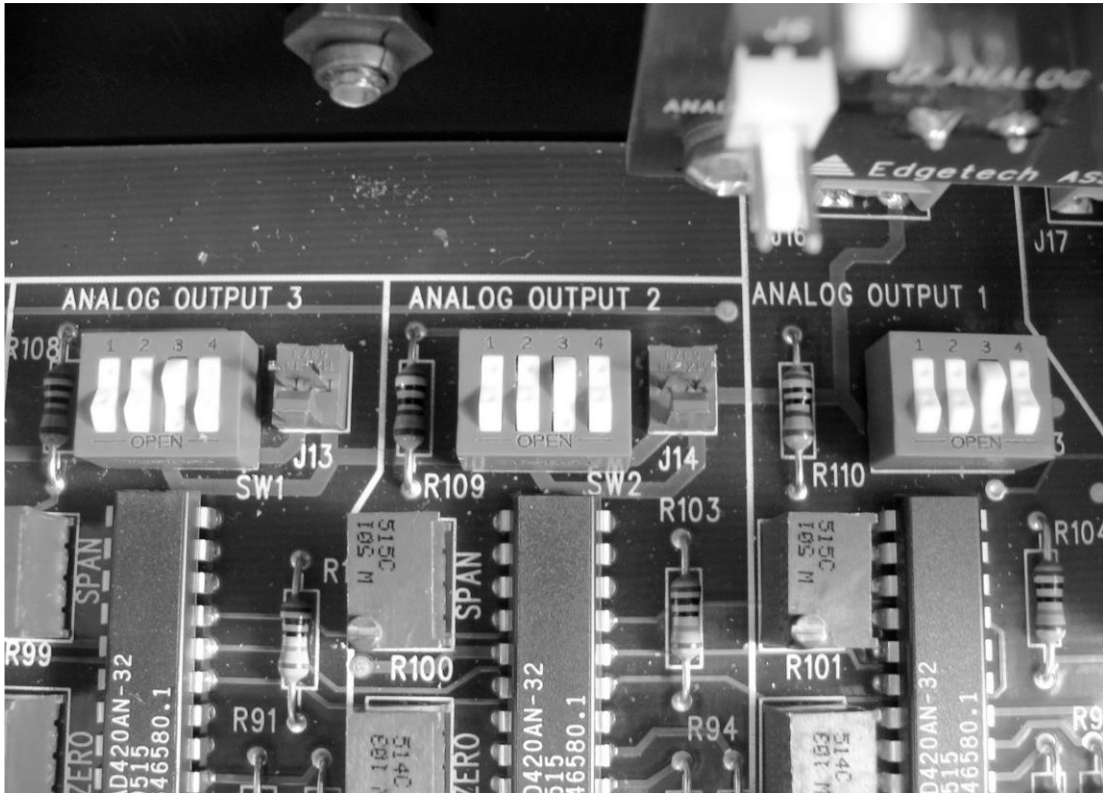

Figure 14-3. Analog Mode Switches

DIP Switch Configuration:

	SWITCH NUMBER			
OUTPUT	1	2	3	4
4 - 20 mA	C	O	C	O
0 - 20 mA	O	C	C	O
0 - 24 mA	O	O	C	O
0 - 5 VDC	C	C	O	C

Where:      O = Open  
                   C = Closed

## 15.0 SPECIFICATIONS

### Dew/Frost Point and Ambient Temperature Range

–40\* to +60°C (–40 to +140°F) S1 Sensor

–50\* to +90°C (–58 to +200°F) S2 Sensor

–75\* to +90°C (–103 to +200°F) S3 Sensor

\*(Lower dew points may require auxiliary cooling)

### Dew/Frost Point and Ambient Temperature Accuracy

±0.2°C (±0.36°F) nominal

### Dew/Frost Point and Ambient Temperature Sensors

3-wire Platinum Resistance Thermometer (PRT), 100 ohms at 0°C, nominal

### Depression

45°C (113°F), nominal, S1 Sensor

65°C (108°F), nominal, S2 Sensor

95°C (171°F), nominal, S3 Sensor

### Auxiliary Coolant Flow Rate (to achieve lower dew points)

1 liter/minute (0.25 gallon/minute) S1,S2 & S3 Sensor - Coolant jacket standard

### Sensor Materials

Chrome, glass, epoxy, anodized aluminum

### Remote Sensors

Up to 75 meters (250 feet) S1 and S2 Sensor

### Slew Rate

1.5°C (2.7°F)/second max. above 0°C

### Repeatability

±0.05°C (0.09°F)

### Hysteresis

Negligible

### Precision

0.1 degrees C or F

### Sample Flow Rate

0.25-2.5 liters/minute (0.5-5.0 SCFH)

### Sensor Max. Pressure

0-21 kg/cm<sup>2</sup> (0-300 psig) S1,S2 & S3 Sensor

## **Operating Temperature**

Control Unit: 0 to +50°C (+32 to +122°F)  
S1 Sensor: -40 to +60°C (-40 to +110°F)  
S2 Sensor: -50 to +100°C(-58 to +212°F)  
S3 Sensor: -50 to +100°C(-58 to +212°F)

## **Display**

LCD graphics backlit display  
0.25-in. high digits

## **Keypad**

Soft keys for setup and operation: Displayed parameter selection: °C/°F toggle: Scroll Menu to change time, date: digital averaging: baud ratio: Manual Auto Balance Cycle initiate: Program Auto Balance Cycle for start time, interval, output Track/Hold: Maximum Heat toggle: Maximum Cool toggle: View/change high and low limits for analog outputs: View/change Alarm parameters, high/low limits, high or low alarms, latched or unlatched relays.

## **Analog Outputs (one standard, three optional)**

### **Voltage**

0 to +5 VDC, scaleable from -100 to +100°C (-148 to +212°F)  
±0.5% accuracy  
1 K ohms minimum load resistance

### **Current**

4 to 20 ma, scaleable from -100 to +100°C (-148 to +212°F)  
1K ohms maximum loop resistance

## **Alarm Relay (one standard, two optional)**

One Form C, SPDT alarm relay(s) rated for 3 amps at 24 VDC, 120 VAC  
Alarm set point programmable from -100 to + 100°C (-148 to +212°F)

## **Pressure Input (optional)**

0 – 25 PSIA, 0-100 PSIA or 0– 250 PSIG standard, other ranges optional

## **Serial Digital Communication**

RS-232C compatible  
9-pin D sub-miniature connector (female)  
Baud Rates: 1200/2400/4800/9600/19200 Protocol: N81  
Output of time, date and dew/frost point at timed intervals  
Programming of most keypad functions.

## **Mirror Condition**

Front panel display.

**Auto Balance Control:**

Manual initiate of ABC at any time

Automatic ABC with start time and interval programmable from keypad or RS-232 port.

Outputs programmable for Track or Hold during ABC.

**Physical:**

Shipping weight:

4.1 kg (9 pounds) with sensor.

Dimensions:

11.1(W) x 4.8 (H) x 16.0 (D) in.

**Mounting Configurations:**

Desktop (standard)

**Power Requirements:**

95 to 240 VAC, 50-60 Hz,

75 watts maximum

## Notes